

**Honeywell**

# ScanPal™ EDA51K Series

Mobile Computer  
powered by Android™



---

## User Guide

---

# Disclaimer

Honeywell International Inc. (“HII”) reserves the right to make changes in specifications and other information contained in this document without prior notice, and the reader should in all cases consult HII to determine whether any such changes have been made. The information in this publication does not represent a commitment on the part of HII.

HII shall not be liable for technical or editorial errors or omissions contained herein; nor for incidental or consequential damages resulting from the furnishing, performance, or use of this material. HII disclaims all responsibility for the selection and use of software and/or hardware to achieve intended results.

This document contains proprietary information that is protected by copyright. All rights are reserved. No part of this document may be photocopied, reproduced, or translated into another language without the prior written consent of HII.

Copyright © 2018-2020 Honeywell International Inc. All rights reserved.

Web Address: [www.honeywellaidc.com](http://www.honeywellaidc.com)

# Trademarks

Google and Android are trademarks of Google LLC.

Bluetooth trademarks are owned by Bluetooth SIG, Inc., U.S.A. and licensed to Honeywell.

microSD is a registered trademark of SD-3C, LLC.

Qualcomm and Snapdragon are registered trademarks or trademarks of Qualcomm Incorporated in the United States and/or other countries.

Other product names or marks mentioned in this document may be trademarks or registered trademarks of other companies and are the property of their respective owners.

# Patents

For patent information, refer to [www.hsmpats.com](http://www.hsmpats.com).

# TABLE OF CONTENTS

Customer Support .....	ix
Technical Assistance .....	ix
Product Service and Repair .....	ix
Limited Warranty .....	ix
<b>Chapter 1 - About the Computer Features.....</b>	<b>1</b>
About the Mobile Computer.....	1
EDA51K Model Overview.....	1
Features of the EDA51K.....	3
About the Battery .....	4
Battery Part Numbers .....	5
Charge the Battery Before Use.....	5
Replace the Battery.....	5
About the Battery Status.....	8
About the Battery Status LED Setting.....	8
Check the Battery Level and Usage .....	10
About Battery Life and Conservation .....	10
Battery Recommendations and Safety Protections.....	11
Enable Airplane Mode .....	11
Power on the Computer .....	12
Welcome Screen.....	12
Unlock the Screen .....	12
Change the Screen Lock to Protect the Computer .....	12
Configure the Screen Backlight .....	13
About the Scan Status LED.....	13
About Audio Features .....	14
Adjust Speaker Volume .....	14

Enable Vibrate Mode or Do Not Disturb.....	15
Audio/Sound Settings.....	15
Insert a microSD Card.....	16
How to Transfer Files.....	17
Configure USB Connection and Transfer Files .....	18
Accessories for the Computer.....	18

## **Chapter 2 - About the User Interface and Applications..... 19**

About the User Interface.....	19
Navigation and Function Buttons .....	20
About the Keypad .....	21
About Status Bar Icons .....	24
Remap a Button or Key.....	24
Restore Default Button Action .....	25
Key WakeUp.....	26
View and Manage Notifications .....	26
Open Quick Settings .....	27
Customize the Home Screen .....	27
Customize the Favorites Tray .....	27
Use Google™ Search.....	28
About Screen Gestures .....	28
Set the Time Zone.....	29
About Honeywell Applications.....	29
Applications You Can Download to the Mobile Computer .....	31
About Honeywell Enterprise Browser.....	31
About Terminal Emulators.....	31
About Honeywell Launcher.....	32
Unlock Developer Options .....	32

## **Chapter 3 - Use the Image Engine ..... 33**

About the Image Engine .....	33
About the Scan Wedge Feature .....	33
Change the Scanner Settings.....	34
Change the Bluetooth Scanner Settings .....	34
Restore Default Scan Settings.....	35

Default Scan Settings .....	35
Add a Scan Setting Profile.....	39
Delete a Scan Setting Profile .....	40
About the Optional Digital Scan Button .....	40
Enable and Configure the Digital Scan Button .....	40
Scan Bar Codes .....	41
About Scanning Configuration Bar Codes .....	41
Use the Scan Demo App .....	42
Change the Scan Demo Symbology Settings .....	42
<b>Chapter 4 - Use the Phone.....</b>	<b>43</b>
About the Phone .....	43
Activate the Phone .....	43
Make a Phone Call.....	45
Answer the Phone .....	45
Switch Apps During a Phone Call.....	46
Make an Emergency Phone Call.....	46
Configure Phone Settings .....	46
<b>Chapter 5 - Use the Camera .....</b>	<b>47</b>
About the Color Camera .....	47
How to Zoom .....	47
Take a Photo .....	47
Record a Video.....	48
Change Camera Settings .....	48
Use the Camera as a Flashlight .....	49
<b>Chapter 6 - Configure the Computer .....</b>	<b>51</b>
How to Configure the Computer .....	51
Start the Settings App.....	51
About the Structure of the Settings App .....	51
About Network Communications .....	61
Connect to Mobile network.....	61

Connect to a Wi-Fi Network .....	62
How to Connect to Virtual Private Networks .....	63
About WWAN Security.....	64
About Certificates .....	65
About Bluetooth Communications.....	66
Connect a Bluetooth Device .....	66
Rename the Computer and View File History .....	67
Rename, Share, or Unpair a Paired Device.....	67
About USB Communications .....	68
USB Troubleshooting.....	68
How to Share Your Mobile Data Connection .....	68
Use Bluetooth or USB Tethering to Share a Data Connection .....	68
Minimum requirements for USB Tethering .....	68
Set up and Connection .....	68
Minimum requirements for Bluetooth Tethering.....	69
Set up and Connection .....	69
About Near Field Communication (NFC).....	69
Developer Information.....	70
About Provisioning Mode .....	70
Enable or Disable Provisioning Mode.....	70

## **Chapter 7 - Manage and Maintain the Computer..... 71**

About Software Updates .....	71
About Transferring Files via USB Connection .....	71
Install Software Updates with AutoInstall .....	72
Optional microSD Card Method.....	72
About the Honeywell Upgrader.....	73
How to view the Installed OTA Version.....	73
Install OTA Updates.....	74
Reboot (Restart) the Computer.....	75
About an Enterprise Data Reset.....	75
Before You Begin .....	75
Enterprise Data Reset the Computer .....	76

About Full Factory Reset .....	76
Before You Begin.....	76
Full Factory Reset the Computer.....	77
Repairs.....	77
Maintenance .....	77
Clean the computer .....	77

**Appendix A - Specifications .....79**

Computer Agency Information .....	79
Label Locations.....	79
Physical and Environmental Specifications .....	80
Imager Specifications .....	80
Bar Code Symbologies .....	80
N6703 Ultra-Slim Imager Engine Reading Distances.....	81
N6703 Ultra-Slim Imager Engine Field of View/Resolution.....	82
N3603 Imager Engine Reading Distances .....	82
N3603 Imager Engine Field of View/Resolution .....	83





# Customer Support

## Technical Assistance

To search our knowledge base for a solution or to log in to the Technical Support portal and report a problem, go to [www.hsmcontactsupport.com](http://www.hsmcontactsupport.com).

For our latest contact information, see [www.honeywellaidc.com/locations](http://www.honeywellaidc.com/locations).

## Product Service and Repair

Honeywell International Inc. provides service for all of its products through service centers throughout the world. To obtain warranty or non-warranty service, return your product to Honeywell (postage paid) with a copy of the dated purchase record. To learn more, go to [www.honeywellaidc.com](http://www.honeywellaidc.com) and select **Service & Repair** at the bottom of the page.

For ongoing and future product quality improvement initiatives, the mobile computer comes equipped with an embedded device lifetime counter function. Honeywell may use the lifetime counter data for future statistical reliability analysis as well as ongoing quality, repair and service purposes.

## Limited Warranty

For warranty information, go to [www.honeywellaidc.com](http://www.honeywellaidc.com) and click **Resources > Product Warranty**.



# ABOUT THE COMPUTER FEATURES

This chapter introduces the ScanPal™ EDA51K mobile computer. Use this chapter to learn about the basic computer features, functions, and accessories.

**Note:** *Device applications and settings vary by computer model and OS version. Your computer may not include all the features shown in the manual.*

## About the Mobile Computer

ScanPal EDA51K mobile computers come equipped for fast Wi-Fi connectivity with a WLAN 802.11 a/b/g/n/ac radio and Bluetooth (v4.2) technology that includes Bluetooth Low Energy (BLE) support. EDA51K-1 models provide additional connectivity with a wireless Wide Area Network (WWAN) radio for high speed data and quality voice support across all network technologies. EDA51K WWAN models also include an integrated global positioning satellite (GPS) receiver that supports GPS protocols including, Simultaneous GNSS Receiver Support for GPS, GLONASS and Beidou GPS.

**Note:** *Throughout this manual, all versions of the mobile computer are referred to as the EDA51K unless information is specific to a particular model.*

## EDA51K Model Overview

Available Feature	EDA51K-0	EDA51K-1
Android operating system*	x	x
1.8 GHz Qualcomm Snapdragon™ SDM450 octa-core processor	x	x
Memory options are dependent on model and scan engine type. <ul style="list-style-type: none"> <li>• 2GB DDR3 RAM, 16 GB flash memory</li> <li>• 3GB DDR3 RAM, 32 GB flash memory</li> <li>• 4GB DDR3 RAM, 64 GB flash memory</li> </ul>	x	x
Choice of Honeywell high performance 2D imager with ergonomic Scan buttons	x	x
WLAN IEEE 802.11 a/b/g/n/ac radio	x	x

Available Feature	EDA51K-0	EDA51K-1
Bluetooth™ V4.2 and Bluetooth Low Energy (BLE) technology support	x	x
NFC technology for short-range data exchange	x	x
Wireless Wide Area Network (WWAN) radio for high speed data and quality voice support across all network technologies		x
Integrated GPS receiver; GPS Supported Protocols: Simultaneous GNSS Receiver Support for GPS, GLONASS and Beidou		x
Mid-tier rugged specifications with IP65 sealing	x	x
Customer-accessible microSD™ slot for removable memory cards up to 128 GB (SDXC/SDHC/SDIO-compliant)	x	x
Value-added software components supporting specialized imaging and OCR functions	x	x
13-megapixel color camera, 1080P video with image stabilization and autofocus technology	x	x
Large, high definition, bright color, outdoor-readable display with responsive multi-touch capacitive touch panel**	x	x
Integrated ambient light sensor, proximity sensor, and accelerometer	x	x
<p>* For information on supported Android OS versions, see the EDA51K Data Sheet, available at <a href="http://www.honeywellaidc.com">www.honeywellaidc.com</a>.</p> <p>** Use of a screen protector may have small effect on the capacitive touch panel performance.</p>		

**Note:** To learn more, see [Appendix A: Specifications](#) beginning on page 79.

# Features of the EDA51K

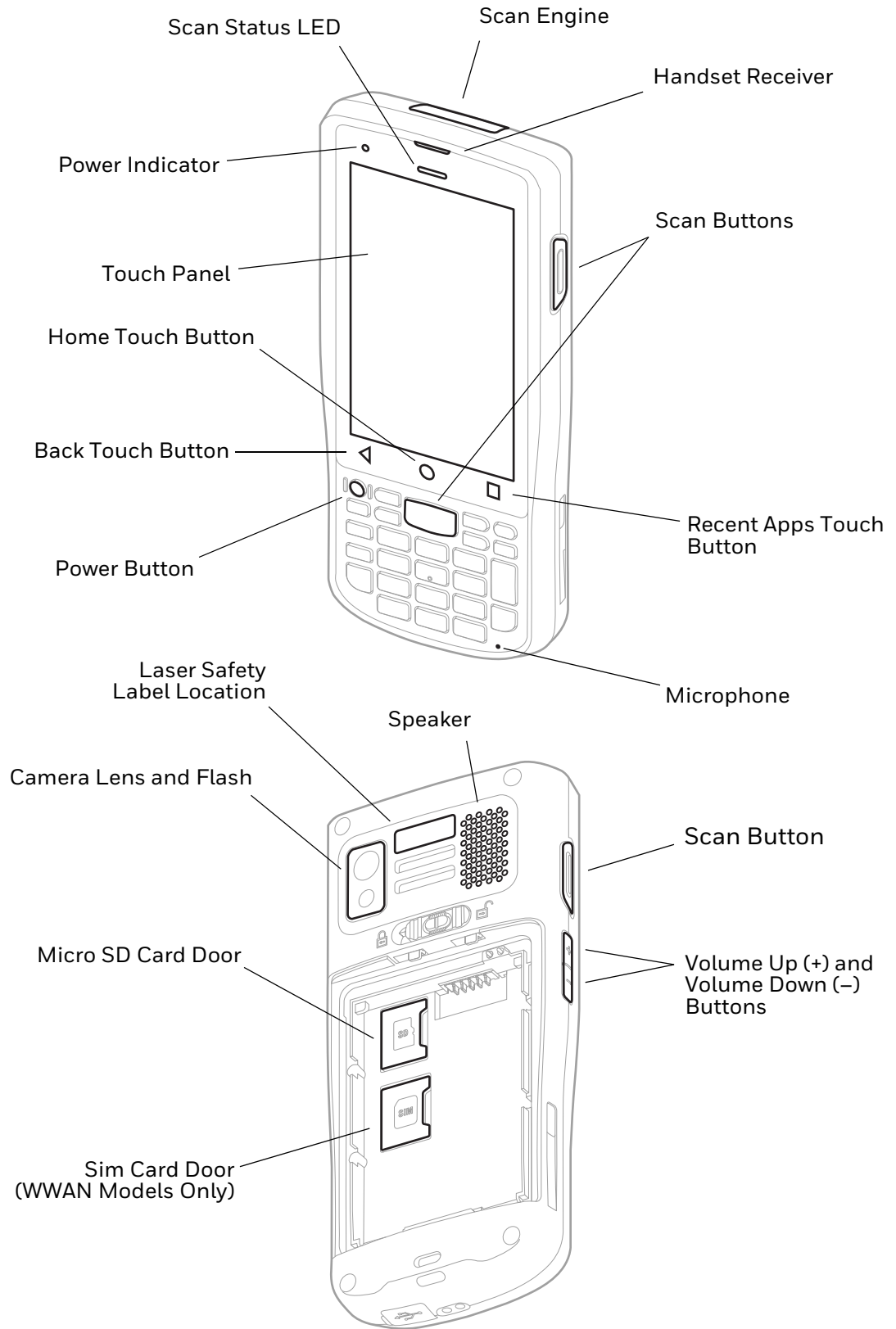

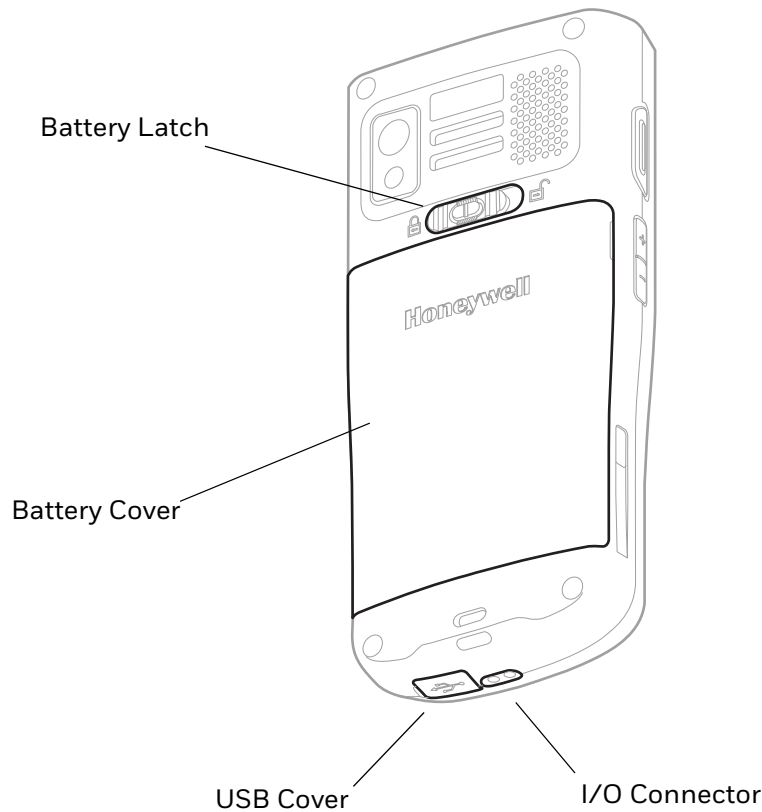

## About the Battery

The computer uses a rechargeable Li-ion battery as its main power source. Several factors determine the life of the battery, such as display brightness, display timeout, input device, extreme temperature, and battery usage. Honeywell recommends that you keep the battery charged at all times to prevent data loss.

ScanPal EDA51K computers are designed for use with battery model BAT-EDA50K (see [Battery Part Numbers](#) on page 5) manufactured for Honeywell International Inc.

For a list of compatible accessories for the EDA51K mobile computer series and their part numbers, see the Accessory Guide, available for download from the EDA51K product page at [www.honeywellaidc.com](http://www.honeywellaidc.com). Contact your local sales representative for replacement battery ordering information.



**Caution: Improper battery replacement or incompatible device usage may result in risk of burns, fire, explosion, or other hazard. Dispose of lithium-ion batteries according to local regulations. Risk of fire and burns if improperly handled. Do not open, crush, heat above 60°C (140°F), or incinerate.**

# Battery Part Numbers



**Caution:** Read [Battery Recommendations and Safety Protections](#) on page 11 and all cautionary markings on the battery, charging peripheral, and device using the battery before attempting to install, use, or charge the battery.

Battery Model Number	Battery Part Numbers
BAT-EDA50K	BAT-EDA50K-1

## Charge the Battery Before Use

ScanPal EDA51K computers ship with the battery significantly discharged of power. Fully charge the battery before using your computer for the first time.

You can charge the battery with a ScanPal EDA50K charging accessory before or after you install the battery in the computer. A fully discharged battery charges in approximately **4.5 hours**.

To charge the battery before you install it in the computer:

- Insert the battery into the EDA50K Quad Battery Charger (EDA50K-QBC) connected to a power source.

To charge the battery after installing it in the computer:

- Insert the computer into a EDA50K Single Charge Base (EDA50K-HB) or Quad Battery Charger (EDA50K-QBC connected to a power source).

**Note:** *Using the computer while charging the battery increases the time required to reach a full charge.*

## Replace the Battery



**Caution:** Improper battery replacement or incompatible device usage may result in risk of burns, fire, explosion, or other hazard. Dispose of lithium-ion batteries according to local regulations. Risk of fire and burns if improperly handled. Do not open, crush, heat above 60°C (140°F), or incinerate.

If your battery power is low, you need to either charge the battery in the computer, or replace it with a charged battery.

## Remove the battery

1. Press and hold the **Power** button until the options menu appears.
2. Tap **Power off**.

3. Disconnect one end of the hand strap from the computer, if installed.  
The hand strap is an optional accessory.
4. Press and hold down the button on the battery latch, and then slide the lock to the unlocked position.
5. Lift up on the edge of the battery cover and remove it from the computer.

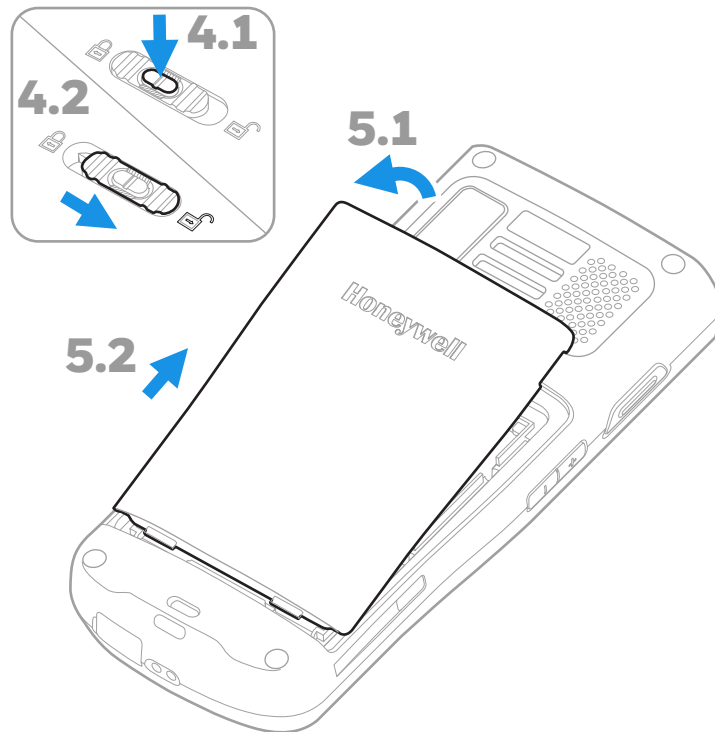

6. Lift the battery from the end and then remove the battery.

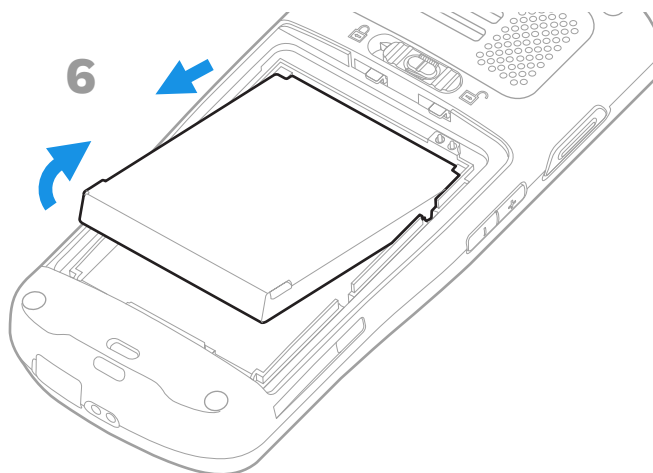



## Install the Battery

**Note:** For battery replacement, refer to [Battery Part Numbers](#) (see page 5).

1. Insert the battery. Slide the connector end in first and then press the battery down.

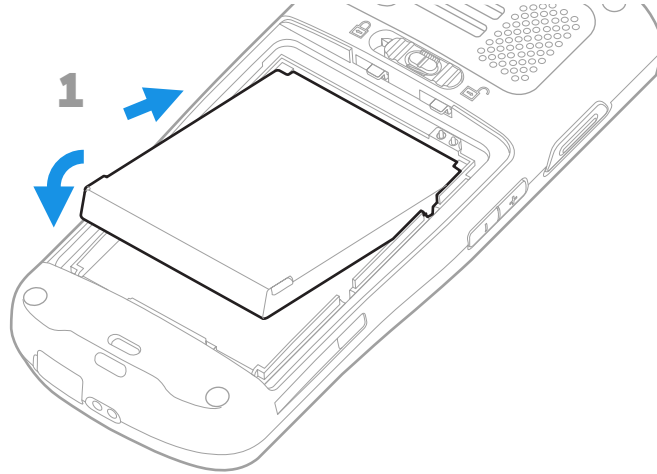

2. Attach battery cover.
3. Slide the lock into the locked position while applying light pressure to the battery door near the lock.

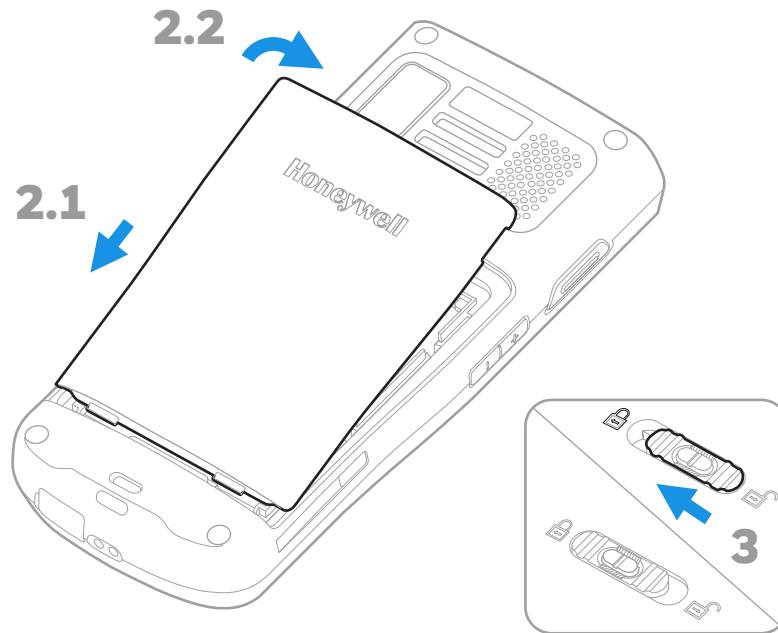







4. Attach the hand strap, if applicable.
5. Press the Power button (approximately 3 secs) to turn on the computer.

# About the Battery Status

Use the battery icon in the Status bar at the top of the screen to see the charge level of your battery. If you want more detailed information on your battery, such as usage time, charge remaining on the battery, or battery health information, open the **Settings** app  > **Battery**.

## Battery Status Icons

Icon	Status
	The battery charge is at 100%.
	The battery charge is at 50%.
	The battery charge is low. You need to charge or replace the battery soon.
	The battery is critically low. You need to replace the battery now or connect the computer to a charging accessory.
	The computer is connected to external power and the battery is charging.
	There is a battery error. Install another battery. If the problem persists, contact Technical Assistance.

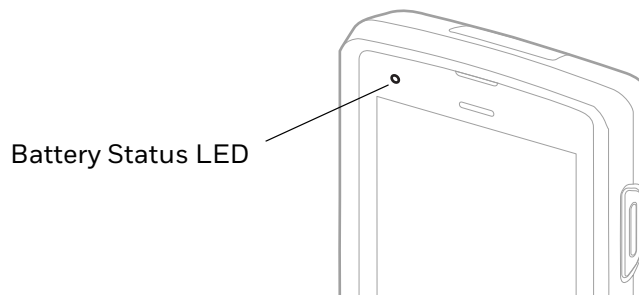

The Battery status LED appears in the upper left corner of the touch screen. The LED color and behavior (e.g., steady on, blinking, off) indicates the charging status of the battery. To view status descriptions and to learn how to modify the Battery LED behavior, see [About the Battery Status LED Setting](#) on page 8.

# About the Battery Status LED Setting

You can change the behavior of the Battery status LED if the out-of-box behavior for a charging battery (blinking green) is not acceptable to your environment.

Available options include:

- **Default Battery LED** (optional Android OS configuration)
- **Honeywell Battery LED** (factory default settings)
- **No Battery LED**

#### **Honeywell Battery LED Behavior (Factory Default/Out-of-Box Configuration)**

<b>Connected to Power</b>	<b>LED State</b>	<b>Description</b>
No	Blinking amber	Battery level is below 15%
No	Off	Battery level is more than 15%
Yes	Steady amber	Battery level is between 0% and 60%
Yes	Blinking green	Battery level is between 60% and 95%
Yes	Steady green	Battery level is above 95%
Either	Blinking red	Battery error

#### **Default Battery LED Behavior (Optional Android OS Configuration)**

<b>Connected to Power</b>	<b>LED State</b>	<b>Description</b>
No	Blinking red	Battery level is below 15%
No	Off	Battery level is 15% or more
Yes	Steady red	Battery level is below 15%
Yes	Steady amber	Battery level is between 15% and 90%
Yes	Steady green	Battery level is 90% or more

Select the No battery LED setting if you want to use the LED as a notification LED for applications or device management solutions. For more information on how to use the LED as a notification LED, see <http://developer.android.com/guide/topics/ui/notifiers/notifications.html>.

## **Change the Battery LED Status Behavior**

To change the battery status LED behavior:

1. Swipe up from the bottom of the Home screen to access all apps.
2. Tap **Settings**  > **Honeywell Settings** > **Battery LED**.
3. Choose one of the options:
  - **Default Battery LED** (optional Android OS configuration)
  - **Honeywell Battery LED** (Factory default settings)
  - **No Battery LED**

# Check the Battery Level and Usage

In addition to the Battery status icon and LED, you can monitor the battery status from the Settings app.

1. Swipe up from the bottom of the Home screen to access all apps.
2. Tap **Settings**  > **Battery**.

The current percentage of battery power remaining and the amount of usage time left on the battery appear on the screen. A list shows the battery usage for individual apps and services. For usage details, select one of the apps or services in the list. You can also access the Battery saver feature from the battery screen.

# About Battery Life and Conservation

Use the reference table below to learn about how to conserve battery power. To learn more about proper battery care, refer to the *Battery Maintenance for Portable Devices white paper* available at [www.honeywell.com](http://www.honeywell.com).

When You Want to:	Do this to Save Battery Power:
Use the computer and the low battery status icon appears or the battery light turns on.	Do one of the following: <ul style="list-style-type: none"><li>• Connect the computer to a charging accessory.</li><li>• <a href="#">Replace the Battery</a> (see page 5).</li></ul>
Stop using the computer for 5 minutes or more.	Make sure that the low battery status icon is not on the screen and that the battery status LED is not on. Press and release the <b>Power</b> button to put the computer to sleep (screen timeout).
Store the computer for more than a day.	<ul style="list-style-type: none"><li>• If you are storing the computer for a few days (e.g., over the weekend), install a fully charged battery or connect the computer to a power source.</li><li>• If you are storing the computer for a longer period of time, fully charge the battery. When the battery is done charging, remove the battery from the computer and store the battery and the computer separately in a cool location.</li><li>• If you store the battery for several months, recharge the battery periodically to keep it at peak performance.</li></ul>
Store the battery outside of the computer.	Batteries self-discharge slowly over time, even when they are not installed in the computer. At a minimum, check stored batteries every three months for their charge state. Recharge as needed.

# Battery Recommendations and Safety Protections





**Caution: Improper battery replacement or incompatible device usage may result in risk of burns, fire, explosion, or other hazard. Dispose of lithium-ion batteries according to local regulations. Risk of fire and burns if improperly handled. Do not open, crush, heat above 60°C (140°F), or incinerate.**

- For maximum battery life, charge the battery at 20 °C (68 °F) to 25 °C (77 °F) and store at 20 °C (68°F) with a 30%-50% charge.
- Do not store the battery at temperatures above 60 °C (140 °F). Storage above 60 °C (140 °F) may damage the battery.
- Charge the battery before use. Battery ships with only a partial charge.
- See [Charge the Battery Before Use](#) on page 5 for approved charging methods. Use of this battery in other devices could result in damage to the device or battery.
- Avoid dropping the battery or computer. If you suspect that the battery or computer is damaged, send it to Honeywell service center for inspection.
- Replace the battery only with another BAT-EDA50K model battery ([Battery Part Numbers](#) on page 5). This battery has been tested in accordance with applicable safety standards. Contact your Honeywell sales representative or distributor if this battery is no longer available.
- Discarded batteries may create a safety hazard. Before disposal, cover the battery contacts with electrical insulating tape.
- Do not modify the battery or attempt to insert foreign objects into it.
- Do not solder directly to the battery contacts.
- Do not drop the battery or apply mechanical shocks or pressure to it.
- Do not immerse batteries into, or expose them to, water or seawater.
- Do not incinerate, microwave, throw into a fire, or expose batteries to temperatures above the maximum rating.
- Do not disassemble a battery or try to open or penetrate its housing.

## Enable Airplane Mode

If you do not need to connect to any WWAN networks, you can enable Airplane mode to turn Off the radios and save battery power.

1. Swipe up from the bottom of the Home screen to access all apps.
2. Tap **Settings**  > **Network & Internet** > **Advanced**.
3. Tap the toggle button next to **Airplane mode**. An airplane icon  appears in the status bar to indicate Airplane mode is turned On.

# Power on the Computer

After you have fully charged and installed a battery, power on the computer for the first time:

- Press and hold the **Power** button for approximately 3 seconds, and then release the button.

## Welcome Screen

The first time you power on the computer, a Welcome screen appears. You can either scan a configuration bar code or manually set up the computer. To learn more about how to [Scan Bar Codes](#), see page [41](#).

During the manual setup process, follow the prompts on the screen as the wizard has you:

- Set the default language.
- Set up the Wi-Fi network connections.
- Set the time, date, and time zone.
- Personalize (name) the computer.
- Set up security and privacy options.

Once you complete the initial setup, the Welcome screen no longer appears when you power on the computer and Provisioning mode is automatically turned Off (disabled). Scanning a bar code to install applications, certificates, configuration files, and licenses on the computer is restricted when Provisioning mode is turned Off. To learn more [About Provisioning Mode](#), see page [70](#).

## Unlock the Screen

The screen lock automatically activates every time the computer is powered on or when the computer wakes from sleep mode. The level of security provided depends on the type of lock set (e.g., Swipe, Pattern, PIN, or Password).

The default setting is Swipe, which provides no protection against unauthorized access to your computer.

- On the lock screen, swipe up from the bottom of the screen.

## Change the Screen Lock to Protect the Computer

After you start using the computer, you should change the screen lock to prevent unauthorized people from accessing the computer after the screen lock activates unless they input the correct password, pin, or pattern.

The recommended setting for the Screen lock is to enable a Password lock. Use a strong password value (e.g., include numbers, characters, special characters, and mix character case).

1. Swipe up from the bottom of the Home screen to access all apps.
2. Tap **Settings**  > **Security** > **Screen lock**.
3. Choose one of the following options:
  - **None**
  - **Swipe**
  - **Pattern**
  - **PIN**
  - **Password**
4. Follow the on-screen prompts to complete the setup.

## Configure the Screen Backlight

The display has an ambient light sensor that automatically adjusts the backlight intensity to conserve power and ensure the display is readable. You can also manually set the backlight intensity if you do not want to use the automated adaptive brightness feature.

1. Swipe up from the bottom of the Home screen to access all apps.
2. Tap **Settings**  > **Display**.
3. Choose one of the following options:
  - To have the computer automatically adjust the brightness for your work environment, turn On the **Adaptive brightness** setting. You can tap **Adaptive brightness** to toggle the feature On or Off.
  - To set the brightness level manually, verify the Adaptive brightness feature is turned Off, and tap **Brightness level**. Adjust the slider to set the brightness level.

## About the Scan Status LED

The Scan Status LED indicates the read status of the imager when scanning a bar code. When active, the LED illuminates below the front speaker. To learn more about how to use and configure the imager engine for scanning, see [Chapter 3: Use the Image Engine](#) beginning on page 33.

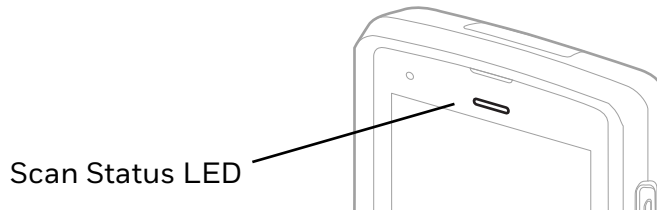

### Scan Status LED Descriptions

LED Color	Description
Green	Good read of a bar code.
Red	Failure to scan bar code. Check to make sure you have the correct symbology enabled.

## About Audio Features

EDA51K has multiple speakers, a microphone, and several software tools to configure sound volume or enable vibration feedback.

### Adjust Speaker Volume





Use the Volume button on the side of the computer to adjust the volume of ringtones, media, notifications, and alarms.

**Note:** *The volume setting varies by OS version.*

To quickly change the active speaker volume level:

- Press the top of the Volume button (+) to raise the volume of the active speaker.
- Press the bottom of the Volume button (-) to lower the volume of the active speaker.

To access the volume quick set menu:

1. Press the center of the **Volume** button.
2. Adjust the volume level using the on-screen menu.
  - Tap the icon at the top to toggle the media volume between sound on , vibrate only , and silent .
  - Use the slider to adjust the media volume.
  - Tap  to turn toggle media volume off.
  - Select  at the bottom to adjust Media, Alarm and Notification volume levels.



## Enable Vibrate Mode or Do Not Disturb

Simultaneously press the **Volume up (+)** and **Power** button to quickly enable Vibrate mode so the computer vibrates instead of emitting sound for notifications and rings.

If you need quiet time without interruptions, enable Do Not Disturb to mute sound, stop vibration, and block notifications. Under the full settings menu, you can set a schedule for when you want Do Not Disturb to automatically turn on and off.

To enable Do Not Disturb manually:

1. Swipe down from the top of the screen to view quick set menu.
2. Tap the **Do Not Disturb** icon  to toggle feature on/off.

**Note:** Tap and hold the icon to access the full settings menu for Do Not Disturb.

## Audio/Sound Settings

This section describes the sound settings you can configure in the **Settings** app.

- Tap **Settings**  > **Sound**.

**Note:** Sound settings are model dependent. Some settings may not be available for your model type.

### Sound Settings

Setting	Description
Media volume	Use the sliders to set the volume for media (e.g., music, videos and games).
Call volume	Use the slider to set caller voice volume.
Ring volume	Use the slider to set incoming call ring tone volume.
Alarm volume	Use the sliders to set the volume for alarms.
Vibrate for calls	Turn haptic (vibration) feedback when for incoming calls.
Do not disturb	Select to configure Do Not Disturb feature and to manually turn it on or off.
Shortcut to prevent ringing	Set the default response when pressing the Volume Up (+) and Power button simultaneously during incoming call notification. Choose either Vibrate or Mute. Use the toggle button to turn feature On or Off.
Phone ringtone	Set the default ring tone for incoming calls.
Default notification sound	Set the default sound for notifications.
Advanced	
Default Alarm sound	Set the default alarm sound.

Setting	Description
Other sounds and vibrations	<p>Turn audio tones and/or haptic feedback (vibration) with On or Off toggle buttons. Options include:</p> <ul style="list-style-type: none"> <li>• Dial pad tones</li> <li>• Screen locking sounds</li> <li>• Charging sounds and vibration</li> <li>• Touch sounds</li> <li>• Touch vibration</li> </ul>

## Insert a microSD Card

You can use a microSD card to increase file storage capacity or to install software. Honeywell recommends the use of Single Level Cell (SLC) industrial grade microSD or microSDHC memory cards with the computer for maximum performance and durability.

**Note:** *Format the memory card before initial use.*

1. Power of the computer.
2. To reveal the SD card door, remove the battery from the computer (see page 5).
3. Lift the edge of the SD card door.

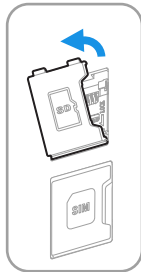

4. Press down gently and slide the card lock away from the open access door. Then, lift the edge of the card lock to reveal the SD card socket.

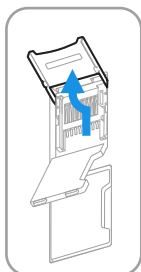

5. Insert the card. The card contacts should face down into the socket.

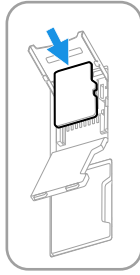

6. Close the card lock and gently slide it toward the open SD card door.

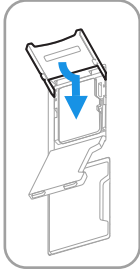

7. Close the card door and press down gently on the edges until flush to the unit surface.

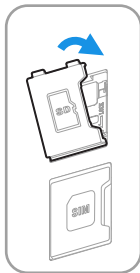

8. Insert the battery, see on [page 7](#).
9. Power on the computer.

## How to Transfer Files

To transfer files you can physically connect the EDA51K mobile computer to your workstation (e.g., laptop or desktop computer) through a USB connection. When the mobile computer is connected and USB is configured for file or photo transfer, use a file browser (e.g., File Explorer or Windows Explorer) on your workstation to transfer files between the two computers. If you are transferring files to and from a Mac, use the Android File Transfer application (available from <https://www.android.com/filetransfer/>).

**Note:** File transfer through a USB connection is disabled by default. You need to configure the USB connection for transferring files or photos.

You can use the cable provided with your unit to connect your mobile computer to your workstation:

- USB cable, type C to type A connection (CBL-500-120-S00-05).

## Configure USB Connection and Transfer Files

**Note:** The EDA51K supports Hi-Speed USB communications (USB2.0) with maximum data transfer rate of 480 Mbps.

1. Connect the EDA51K to your workstation using a USB cable.
2. On the EDA51K, swipe down from the top of the screen to see the notifications.
3. Tap the **Android System** charging notification twice to open the options menu.
4. Select either **File Transfer** or **PTP** to transfer photos.
5. Open the file browser on your workstation.
6. Browse to the EDA51K. You can now copy, delete, or move files between the EDA51K and your workstation.

## Accessories for the Computer

The EDA51K ships with a partially discharged battery, power adapter with regional plug adapter, and a USB charge/communication cable (Type C to Type A). All other accessories are ordered and shipped separately.

For a complete list of compatible accessories for your mobile computer and their part numbers see the *EDA50K/EDA51K Series Accessory Guide* available for download at [www.honeywellaidc.com](http://www.honeywellaidc.com).

Contact your local sales representative for ordering information.

Accessory	Description
Single Charging Dock (EDA50K-HB)	Charge cradle for charging the ScanPal EDA50K/EDA51K (Compatible with EDA51's scan handle). Power cord and power supply sold separately.
Quad battery charger (EDA50K-QBC)	Quad battery charger for charging BAT-EDA50K-1 batteries. Kit contains power supply and power cord.
Hand strap (EDA51K-HS)	The hand strap attaches to EDA51K mobile computer.
USB Cable (CBL-500-120-S00-05)	Charge/USB communication cable for ScanPal EDA51K. Type C to Type A USB, 1.2 m.
Wall Charger with Plug adapter	Power adapter and regional plug for use with USB cable CBL-500-120-S00-05 to charge the ScanPal EDA50K/EDA51K from a wall power outlet.

# ABOUT THE USER INTERFACE AND APPLICATIONS

Use this chapter to learn about the user interface and how to interact with the screen. You can also use this chapter to learn about the Honeywell applications on the computer.

## About the User Interface

The Android operating system provides a touch-friendly and easy-to-navigate user interface. When you turn on the computer, the Home screen is the first screen that appears after language provisioning and the startup Wizard is complete.

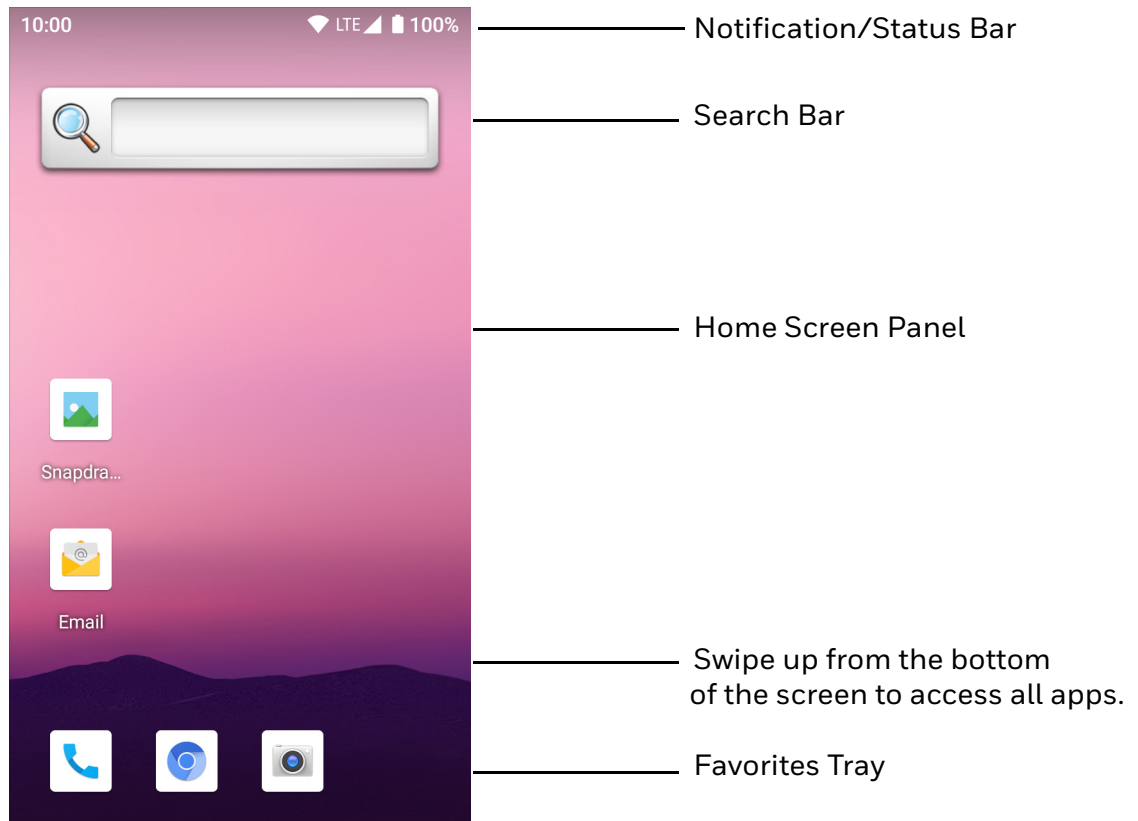

## Home Screen Features





Item	Description
Notifications Panel/ Status Bar	Status icons to the left tell you when an app has sent notifications, such as an arriving message. System icons to the right display the current WWAN and network connection state and battery level.
Search Bar	Search the Internet or the computer using Google™.
Home Screen Panel	You can create more than one custom Home screen panel. Swipe left or right on the Home to switch between your custom panels.
Favorites Tray	App icons in the customizable tray are visible on all Home screen panels.

## Navigation and Function Buttons

Your mobile computer has touch buttons on the front panel below the Favorites tray and hardware buttons located on the sides for easy navigation and quick feature access when using the computer.

For button locations, see [Features of the EDA51K](#) on page 3.

### Navigation and Function Buttons

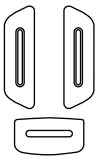



Button	Description	
	Back	Tap to return to previous screen.
	Home	Tap to return to the Home screen.
	Recent Apps	Tap to view and switch between recently used apps.
	Volume	Press the top of the <b>Volume</b> button(+) to raise the active speaker volume. Press the bottom of <b>Volume</b> button (-) to lower the active speaker volume.
	Scan	Press the right, left or front <b>Scan</b> button to trigger the scanner.

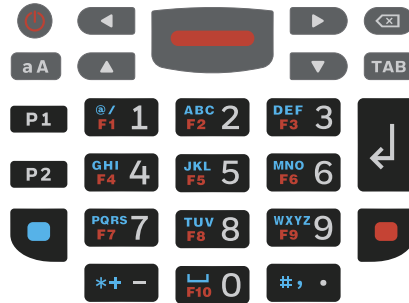





# About the Keypad

The EDA51K is equipped with a keypad that provides easy screen navigation, numeric input, alphabetic and symbology input using two modifier keys (blue and red), function keys (F1 - F10) and two additional soft keys (P1 and P2) for custom remapping.



## Keypad Layout

Key	Description	
	Power	<p>When the computer is turned off:</p> <ul style="list-style-type: none"> <li>Press and hold for approximately 3 seconds, and then release to turn the computer on.</li> </ul> <p>When the computer is turned on:</p> <ul style="list-style-type: none"> <li>Press and release to toggle the computer in or out of sleep mode (screen timeout).</li> <li>Press and hold the Power button until the options menu appears. Select an action, Power off, Restart, Screenshot or Emergency.</li> <li>Press and hold for approximately 8-seconds to automatically restart the computer, if the touch screen is unresponsive.</li> </ul>
	Scan	Press to trigger the scanner.
	Cursor Direction	Move the cursor on the screen up, down, left and right.
	Shift/Caps Lock	<p>When the blue modifier key has been used to enable alphabet/symbol mode:</p> <ul style="list-style-type: none"> <li>Press the Shift/Caps Lock key once to shift to upper case input for a single character.</li> <li>Press the Shift/Caps Lock key twice to enable caps lock.</li> </ul> <p>The Shift/Caps Lock key does not affect key results if the blue modifier has not been pressed unless the key is remapped using the Remap Key feature.</p>

Key	Description	
	Enter (ENT)	Insert a carriage return where the cursor is located and move to next line or confirm a selection.
	Delete (DEL)	Use to delete a character.
	Tab	Switch menus or insert a tab.
	P1 and P2 Soft Keys	Use the key remap feature to map specific functions to P1 and P2 keys. For example, you can map the P1 key to open the volume adjustment menu. <ul style="list-style-type: none"> <li>Settings &gt; Honeywell Settings &gt; Keyremap</li> </ul>
	Numeric Keys and Blue or Red Modifier Keys	<ul style="list-style-type: none"> <li>When no modifier is enabled, press a numeric or symbol key to input the number or symbol marked in white on the key.</li> <li>Press the blue modifier key to input the alphabetic letter(s) or symbol(s) marked in blue on the key.</li> <li>Press the red modifier key to access the function (e.g., F1, F10) marked in red on the numeric key.</li> </ul> <p>To learn more see, <a href="#">How to Use the Keypad and Modifier Keys</a>.</p>
	Space	To add a space press the blue modifier key, and then press zero key.

## How to Use the Keypad and Modifier Keys

The computer keypad includes blue and red modifier keys for typing alphabetic characters, special characters and utilizing the function keys (F1 - F10). The keypad also has customizable soft keys (P1 to P2) that can provide two additional key functions.

To learn more about customizing the key functions, see [Remap a Button or Key](#) on page 23.

### To type a number:

- Press the relevant number key.

### To type a lower case alphabetic character or symbol:

- Press the blue modifier key once.

An **a** appears in the status bar to indicate that the keypad is in alphabetic mode.

- Press the key for the letter or special character shown in blue.



Example: Type the word “and” in lower case letters using the key sequence below.

1. Press the modifier blue key once.
2. Press number 2 key once.
3. Press number 6 key twice in rapid succession.
4. Press number 3 key.



### To type a single uppercase alphabetic character:

1. Press the blue modifier key once.  
An **a** displays in the status bar.
2. Press the shift/caps lock key.  
The **a** changes to **A** in the status bar when caps lock is turned on.
3. Press the character key.  
The **A** changes to **a** in the status bar to indicate caps lock has been automatically turned off.

Example: Type a capital “D” using the key sequence below.

1. Press the modifier blue key once.
2. Press shift/caps lock key once.
3. Press number 3 key once.



### To type all uppercase alphabetic character:

1. Press the blue modifier key once.  
An **a** displays in the status bar.
2. Press shift/caps lock key twice to lock it on.  
The **a** changes to **A** in the status bar when caps lock is turned on and locked.
3. Press the character key.

Example: Type the word “TEA” in capital letters using the key sequence below.

1. Press the modifier blue key once.
2. Press shift/caps lock key twice in rapid succession.
3. Press the number 8 key once.
4. Press the number 3 key twice in rapid succession.

5. Press number 2 key once.
6. Press shift/caps lock key once to turn caps lock off.



## About Status Bar Icons

Status and notification icons show you the current status of your network, the battery, notifications, and sounds. Use the table below to understand some of the most common icons.

### Status and Notification Icons

Icon	Description	Icon	Description
	Pending alarm and Alarm is set		Vibrate mode is turned On
	New text message or multimedia message		Airplane mode is turned On
	Error with text or multimedia message delivery		Bluetooth is turned On
	New email		SD card is full
	Computer is connected to a PC with a SUSB cable		Wi-Fi network is connected with full signal strength
	Synchronizing data		Wi-Fi network is connected but no signal strength
	Error with sync or sign-in		Phone connected with full amount of bars
	Computer is connected with Ethernet		Phone connected with full amount of bars but no Internet connection

## Remap a Button or Key

You can change the default function of the physical buttons (e.g., Left Scan, Right Scan, Volume up and Volume down) and some of the keys.

**Note:** *If a key does not support remapping, a notification appears to change the input method when the key is selected.*

1. Swipe up from the bottom of the Home screen to access all apps.
2. Tap **Settings** > **Honeywell Settings** > **Keyremap**.
3. Tap the plus sign (+).
4. Press the button you want to remap.

5. Tap **OK**.
6. Select a tab to use for remapping, and then select or enter a value as required.
  - **KEYS**  
Choose a key function to assign to the selected key.
  - **APPS**  
Select an app that will launch when the selected button is pressed.
  - **ACTIONS**  
Enter an action that will be executed when the button is pressed, for example, "com.android.settings/com.android.settings.wifi.WifiSettings".
  - **COMMAND**  
Enter a command that will be executed when the button is pressed, for example, "start -n packagename/activityname param".
  - **TEXT**  
Enter a key combination that will be executed when the button is pressed, for example, "CTRL,C". See the next section for more information.
7. The remapping is displayed on the Keyremap screen.



## Using TEXT Commands

You can use TEXT commands to map multiple keys or a key combination.

- Only lowercase characters are supported, but they must be entered in upper case. For example, entering "H,E,L,L,O" will produce "hello". "H,e,l,l,o" will produce "h". To remap to a string with capital letters like "HELLO", use a series of key combinations like, "CAPS\_LOCK,H,CAPS\_LOCK,E,CAPS\_LOCK,L,CAPS\_LOCK,L,CAPS\_LOCK,O".
- Shifted characters can be remapped in the format SHIFT,<key>. For example, "SHIFT,1" returns "!", "SHIFT,2" returns "@", etc.
- A space must be defined using the Keyname like "A,SPACE,B".
- Key names separated by comma are considered a string not a key, so "F,1,E,N,T,E,R" will produce the string "f1enter". "F1,ENTER" will produce the events as if Function Key 1 and an Enter key have been pressed.

## Restore Default Button Action

To restore the default button action:

1. Swipe up from the bottom of the Home screen to access all apps.
2. Tap **Settings**  > **Honeywell Settings** > **Keyremap**.
3. Tap the clean icon .

4. Choose the remapped button(s) you want restored to the default setting(s).
  - Tap the check box next to the button.
- OR
- Tap **ALL SELECT** to choose all the buttons.
5. Tap **DELETE**.
6. Tap **OK** to confirm action.

## Key WakeUp

Use Key WakeUp to set the key(s) or button(s) you want to use to wake the computer from sleep mode (screen timeout).

1. Swipe up from the bottom of the Home screen to access all apps.
2. Tap **Settings** > **Honeywell Settings** > **Key WakeUp**.
3. Turn keys on or off depending on your preference. Choose from Left Scan, Right Scan, Middle Scan, Up or Down.
4. Tap **Apply** to save your settings.

**Note:** To apply the default configuration, tap the **Reset** button instead of apply.

## View and Manage Notifications

You can view recent events on the computer, manage system notifications, change a setting or quickly respond to an app notification by opening the notifications panel.

When a notification icon appears in the status bar at the top of the screen:

1. Swipe down from the top of the screen to open the notifications panel.
2. Respond to the notification. You can take one of the following actions:
  - Tap the notification to open the associated app.
  - Tap a quick-reply or action command (e.g., Reply, Archive), if available.
  - Swipe the notification sideways, off the screen to dismiss it. Note that some notifications cannot be dismissed.
  - Slide the notification left or right to reveal the Settings icon . Choose between **Show notifications silently**, **Don't silence**, or **More settings**.

To close the notification panel, swipe up from the bottom of the screen, or tap the **Back** or **Home** buttons.

## Open Quick Settings

Use the Quick Settings screen for easy access to common settings. Tap an icon to toggle the feature On/Off or to open additional settings.

- To open Quick Settings, swipe down from the status bar at the top of the screen. To expand the Quick Setting menu, swipe down again from the status bar at the top of the screen.
- To close Quick Settings, swipe up from the bottom of the screen or tap the **Back** or **Home** buttons.

## Customize the Home Screen

You can add application icons to any Home screen for easier access.

1. Swipe up from the bottom of the Home screen to access all apps.
2. Tap and hold the app you want to add, and then slide the icon slightly out of position.
3. Drag and drop the app icon into place.
  - If you want to add another home screen, drag the icon to the right edge of the screen before releasing the icon.
  - If you want to create a folder, drag and drop the icon on top of another icon.

To add a Widget or customize the look of the Home screen:

1. Tap and hold an empty section of the screen.
2. Select either **Wallpapers**, **Widgets**, or **Home settings**.

## Customize the Favorites Tray

Modify the Favorites tray to contain the apps you use the most.

1. Tap and hold the app icon you want to replace on the Favorites tray. Slide the icon out of place slightly to activate feature.
2. Drag and drop the app on **“X Remove”** at the top of the screen.
3. Swipe up from the bottom of the screen to access all apps.
4. Tap and hold the icon of the app you want to add.
5. Drag and drop the icon into position on the Favorites tray.

## Use Google™ Search

Use the Google Search field at the top of the Home screen to help you find anything you need on the computer or on the web.

1. At the top of any Home screen, tap inside the Google Search box and begin to type your search term.

As you type, suggestions from Google web search appear below the Search box, and results from the computer (such as apps or contacts) appear below the web search results.

2. Tap a suggestion to search for it immediately, or touch the arrow to add the term to the search field without starting to search.

## About Screen Gestures

Use your fingers or the stylus to manipulate icons, buttons, menus, the on-screen keyboard, and other items on the screen.

- **Tap**

Tap to select something, toggle a setting On or Off, or activate a field for text entry. An on-screen keyboard automatically appears for text entry.

- **Tap and hold**

Tap and hold an item but do not lift your finger or stylus until an action occurs.

- **Drag and drop**

Tap and hold an item, and then slide your stylus or finger across the screen until you reach the target position. Lift your finger or stylus off the screen to drop the item in place.

- **Swipe**

Quickly move your finger across the screen, without pausing when you first touch. For example, you can swipe a Home screen left or right to view the other Home screens.

- **Slide**

Slowly move your finger across the screen, without pausing when you first touch. For example, you can slide a notification to the left until the Settings gear is revealed.

- **Double-tap**

Tap quickly twice on a web page, map, or other screen to zoom in. Double-tap again to zoom out.

- **Pinch**

In some apps, you can zoom in and out by placing two fingers on the screen at once and pinching them together (to zoom out) or spreading them apart (to zoom in).

## Set the Time Zone



The computer gets the current date and time from its network connection. If preferred, you can change this behavior and manually set the time zone for your location.









1. Swipe up from the bottom of the Home screen to access all apps.
2. Tap **Settings**  > **System** > **Date & time**.
3. Tap **Use network-provided time** to turn off automatic network retrieval.
4. Tap **Time zone** and choose the time zone for your location.

## About Honeywell Applications



Honeywell applications help you troubleshoot and connect your mobile computer to other devices and networks. Some of the applications in this table are located in the Power Tools app. To learn more about Honeywell Power Tools, go to [www.honeywellaidc.com](http://www.honeywellaidc.com) to download the *Scanpal Power Tools User Guide*.

### Honeywell Applications Available on the Computer

Icon	Application	Description
	AutoInstall Settings	Enable the AutoInstall feature, to automatically install *.zip or *.apk files containing applications saved in the Internal shared storage\honeywell\autoinstall folder and IPSM card\honeywell\autotinstall folder on the computer during the power-up boot or reboot process.
	Demos	Honeywell Demo apps demonstrate the basic capabilities of the computer and are not intended as functional business solutions. The demos included, demonstrate scanning, signature capture, NFC functionality, and printing via Bluetooth technology. Information on how to create custom applications for your Honeywell computer can be found in the Honeywell Software Development Kit (SDK) for Android, available from the <a href="#">Technical Support Downloads Portal</a> .

Icon	Application	Description
	Enterprise Settings	Enterprise Settings can help customers achieve some common customized needs. Support UI interface, SDK and Broadcast way.  Scan Settings <ul style="list-style-type: none"> <li>• Scan result broadcast action</li> <li>• Scan result broadcast key</li> <li>• Scan button key down broadcast</li> <li>• Scan button key up broadcast</li> </ul> General Settings <ul style="list-style-type: none"> <li>• Function control</li> <li>• Function restriction</li> <li>• Custom boot animation</li> <li>• Grant/revoke runtime permissions</li> <li>• Set default launcher</li> </ul>
	HUpgrader	Use to the HUpgrader app to view the current OTA version on the computer, check for updates, or initiate an OTA upgrade from storage.
	HQ Config	HQConfig is used for offline rapid deployment. Synchronize content: common settings, scan settings, applications and firmware upgrades.
	HonRfid	When the EDA51K is connected to an Honeywell RFID product, the HonRfid app is used to demonstrate the functions of Honeywell RFID products (e.g., inventory, RFID tag reading, writing and locking, power adjustment, frequency adjustment, etc).
Power Tools		
	BattMon	BattMon provides information on the charge status and health of the battery, and provides access to activate battery status notifications and battery charging history logs.
	ConfigApps	The ConfigApps Power Tool gives you the ability to enable or disable apps installed on the computer and to uninstall app updates that may be causing storage or performance issues. You can also view the total number of apps on the computer and the total number of apps currently disabled.
	Configure Autorun	Configure Autorun provides the ability to set applications to automatically run after a restart.
	Diagnostic Information	Diagnostic Information provides access to system statistics, notifications and version information about the computer.
	EZConfig	EZConfig supports advanced customization and configuration of the hand held computer. EZConfig includes a standard XML editor and configuration bar code scanner feature.



Icon	Application	Description
	WiFi Diagnostic	Use application to: <ul style="list-style-type: none"> <li>View Wi-Fi radio status information about a connected access point or a list of other available access points in range of the Wi-Fi radio.</li> <li>Use the Route utility to view packet destination gateway information across the subnets.</li> <li>Use the IPConfig utility to view IP parameters for the on-board network adapters.</li> <li>Use the Ping utility to verify communication links or to make sure a specific IP address is working.</li> </ul>
	Wireless Tether	Use to enable range tracking and customize out-of-range alerts for Bluetooth devices paired and tethered to your hand held computer.

## Applications You Can Download to the Mobile Computer

You can download Honeywell applications to extend the capabilities of the computer. You may need to purchase a license to run some applications. To learn more about the applications described in this section and other Honeywell software solutions, go to [www.honeywellaidc.com](http://www.honeywellaidc.com) > **Browse Products** > **Software**.

### About Honeywell Enterprise Browser

Enterprise Browser is a locked-down enterprise Web client application designed for Honeywell computers. It provides a controlled Web application environment that helps enterprises increase productivity and reduce IT management expenses. You can configure Enterprise Browser for your specific application requirements and design custom web applications that run through the Enterprise Browser to provide your users with an easy-to-use yet controlled experience.

If Enterprise Browser is not included on your computer model, you can download a trial version for evaluation. After the evaluation period expires, you need to purchase a license. For more information about Enterprise Browser, visit [www.honeywellaidc.com](http://www.honeywellaidc.com).

### About Terminal Emulators

Honeywell offers several terminal emulator solutions that allow users to manage their mobile devices by providing reliable data transfer between the host mobile device and terminal. Terminal emulators can be used for remote management and configuration of devices, data collection and analysis, and session management.

Depending on the computer model, a terminal emulator may come preinstalled on the device. If a terminal emulator is not included on your model, you can download a trial version for evaluation. After the evaluation period expires, you need to purchase a license. For more information, visit [www.honeywellaidc.com](http://www.honeywellaidc.com).



## About Honeywell Launcher

Launcher is a configurable locked-down menu program designed for Honeywell computers that prevents end-users from accessing the start menu and other non-authorized applications. Use Launcher to provide a platform where your mobile computer users are limited to running only company-approved applications and prevent them from initiating unauthorized configuration changes. You can also use Honeywell Launcher together with Honeywell Enterprise Browser to create a single-purpose device configuration.

If Launcher is not included on your computer model, you can download a trial version of the software for evaluation. After the evaluation period expires, you need to purchase a license. For more information about Launcher, visit [www.honeywellaidc.com](http://www.honeywellaidc.com).

## Unlock Developer Options

Developer options only appear in the Settings app if you unlock the feature. If you are a developer working with the computer, you can easily unlock the additional settings to use for testing and debugging applications under development for the computer.

1. Swipe up from the bottom of the Home screen to access all apps.
2. Tap **Settings**  > **About phone**.
3. Tap **Build number** seven times. A message appears informing you that you are now a developer.
4. Open **Settings**  > **System** and scroll to the bottom of the list.
5. Tap **Developer Options**.

# USE THE IMAGE ENGINE

Use this chapter to understand how to scan bar codes, configure the scan settings, and capture images using the integrated image engine in the computer.

## About the Image Engine

The Scanpal EDA51K series offers the following Honeywell high-performance imager options:

- N3603 Imager Engine
- N6703 Ultra-Slim Imager Engine

Use the imager as a scanner to read 1D and 2D bar code symbologies, composite symbologies, and postal codes. It also supports omni-directional scanning for greater flexibility in real-world settings. By default, the scanner feature is enabled and uses the default scan profile. You can modify the **Default Profile** or create new profiles for custom applications from the **Settings > Honeywell Settings > Scanning**.

Use the imager as a camera to capture black and white images, such as signatures or pictures of damaged inventory.

**Note:** *Instead of using the internal imager, you can also use Bluetooth communications to connect the computer to an external scanner, such as the Granit™ 1981i and 1911i.*

## About the Scan Wedge Feature

The scan wedge feature sends scanned bar code data to an active application as Android keypad input. To scan a bar code as keyboard input, open an application that accepts text input and then scan a bar code. You can use applications that are coded to use the scanner or applications that receive data through the scan wedge feature. If an application claims the scanner through the BarcodeReader API, the scan wedge feature is temporarily disabled.

You can find information on how to create custom applications for the computer in the Software Development Kit (SDK) available for download from the Technical Support Downloads Portal at <https://hsmftp.honeywell.com>. Once you create an account and enter the portal, navigate to **Software > Software and Tools > Developer Library > SDKs for Android**.

## Change the Scanner Settings

Changes you make to the Default profile apply to all applications with no profile assigned.

1. Swipe up from the bottom of the Home screen to access all apps.
2. Tap **Settings**  > **Honeywell Settings** > **Scanning**.
3. Tap **Internal Scanner** > **Default Profile**.
4. Select from the following:
  - **Data Processing Settings**,
  - **Symbology Settings**,
  - **Decode Settings**,
  - **Imager Settings**,
  - **Trigger Settings**, or
  - **Notification Settings**.
5. Modify the settings to meet your application needs.

To learn more about Scanner settings, [Default Scan Settings](#) on page 35.

## Change the Bluetooth Scanner Settings

When the Bluetooth scanner is paired, changes can be made to the Default profile for the scanner.

1. Swipe up from the bottom of the Home screen to access all apps.
2. Tap **Settings**  > **Honeywell Settings** > **Scanning**.
3. Tap **Bluetooth Scanner** > **Default Profile** > **Data Processing Settings**.
4. Modify the settings to meet your application needs.

To learn more about Scanner settings, [Data Processing Settings](#) on page 35.

# Restore Default Scan Settings

You can easily discard all changes you made to the Default profile and restore the default values.

**Note:** When you choose the *Restore all defaults* option from any of the settings screens in a profile, all the settings in that profile return to their default values.

1. Open the **Default profile**.
2. Tap  in the upper right corner of any of the scan settings screens for the profile.

Tap **Restore all defaults**.

# Default Scan Settings

Use the following sections to understand the scan settings available for scanner profiles. To learn how to create a new profile, see page [39](#).

## Data Processing Settings

Use the Data Processing Settings to specify how bar code data is processed by the computer.

### Data Processing Settings

Setting	Description	Default										
Wedge	Enable or Disable the scan wedge feature	Enabled										
Wedge Method	Specify wedge method: Standard or Keyboard	Standard										
Charset	Select the character set to use when interpreting the bar code data into a string.	ISO-8859-1										
Prefix	Defines the string added before the decoded bar code data. Substitutions occur within the Prefix string values. <table border="1"><thead><tr><th>Substring</th><th>Replacement Character Code</th></tr></thead><tbody><tr><td>\r</td><td>13</td></tr><tr><td>\n</td><td>10</td></tr><tr><td>\t</td><td>9</td></tr><tr><td>\\</td><td>'\'</td></tr></tbody></table>	Substring	Replacement Character Code	\r	13	\n	10	\t	9	\\	'\'	None
Substring	Replacement Character Code											
\r	13											
\n	10											
\t	9											
\\	'\'											

Setting	Description	Default										
Suffix	<p>Defines the string added after the decoded bar code data. Substitutions occur within the Suffix string values.</p> <table border="1"> <thead> <tr> <th>Substring</th> <th>Replacement Character Code</th> </tr> </thead> <tbody> <tr> <td>\r</td> <td>13</td> </tr> <tr> <td>\n</td> <td>10</td> </tr> <tr> <td>\t</td> <td>9</td> </tr> <tr> <td>\\</td> <td>\</td> </tr> </tbody> </table>	Substring	Replacement Character Code	\r	13	\n	10	\t	9	\\	\	None
Substring	Replacement Character Code											
\r	13											
\n	10											
\t	9											
\\	\											
Wedge as keys	List of character values to wedge as keys, represented as a comma-separated list of decimal values.	9, 10, 13										
Data Editing Plugin	Specify a Total Freedom data editing plug-in and edit plug-in settings.	None										
Symbology Prefix	<p>Specify a symbology identifier prefix to the bar code data. Options include:</p> <ul style="list-style-type: none"> <li>None</li> <li>Honeywell</li> <li>AIM</li> </ul>	None										
Launch Browser	<p>Enable or disable URL bar code handling. If a bar code starts with http:// or https://, the browser opens using the bar code data as a URL.</p> <p>Corresponds to BarcodeReader property: PROPERTY_DATA_PROCESSOR_LAUNCH-BROWSER</p>	Enable										
Scan to Intent	<p>Enable or disable special handling of scan-to-intent bar codes.</p> <p>Applies to bar codes in one of the following formats:          '// ACTION          '// ACTION '\$' extra-data</p> <p>Where: ACTION and extra-data are any string of characters.</p> <p>Launches an application listening for the intent.          Intent action:          "com.honeywell.scantointent.intent.action." + ACTION          Intent extra:          "com.honeywell.scantointent.intent.extra.DATA" contains the remainder of the bar code data after the first '\$' character.</p> <p>Corresponds to BarcodeReader property: PROPERTY_DATA_PROCESSOR_SCAN_TO_INTENT</p>	Enabled										
Launch EZ Config	<p>Enable or disable special handling of EZConfig bar codes.</p> <p>Applies to EZConfig bar codes that are encoded with the Aztec symbology and contain specific header data.</p> <p>Corresponds to BarcodeReader property: PROPERTY_DATA_PROCESSOR_LAUNCH_EZ_CONFIG</p>	Enabled										

Setting	Description	Default
Data Intent	Enables the reception and processing of bar code data without using an SDK or library.	Disabled

## Symbology Settings

Use the Symbology Settings to enable or disable bar code symbologies for the selected scan setting profile.

- Tap the check box next to a symbology name to enable (check mark) or disable (no check mark) decoding for that symbology.

Tap the symbology name to view and modify additional configuration parameters for the symbology selected.

To view a list of default settings for supported symbologies, see [page 80](#).

## Decode Settings

Adjust the Decode Settings when scanning bar codes that are densely packed or poor quality.

### Decode Settings

Setting	Description	Default
Center Decode	<p>When enabled, the imager scans and decodes a bar code only if part of the bar code is at the center of the aimer window. This is useful in situations where several bar codes may be very close together in the imager field-of-view.</p> <ul style="list-style-type: none"> <li>• Tap the check box to toggle the feature On or Off.</li> <li>• Select <b>Center Decode</b> to adjust the Window dimensions. Honeywell recommends leaving the settings at 50 (default) to define the “center” area for the bar code. Configurable parameters: <ul style="list-style-type: none"> <li>• Window top</li> <li>• Window bottom</li> <li>• Window left</li> <li>• Window Right</li> </ul> </li> </ul>	Enabled
Decode Security	Use this setting to control the reading tolerance of the decoder. Lower settings are more lenient when reading low quality bar codes while higher values are more strict.	2
Poor Quality 1D Reading	Enable this setting when scanning damaged or badly printed 1-D bar codes to improve bar code read success.	Disabled
Decoder Timeout	Set the amount of time in seconds that the scanner will timeout if a readable barcode is not found.	150

Setting	Description	Default
Video Mode	<p>Use this setting to specify whether normal or inverse decoding for linear symbologies is enabled during the execution of Decode. By default normal video is enabled.</p> <p>Options include:</p> <ul style="list-style-type: none"> <li>• Normal</li> <li>• Inverse</li> <li>• Normal and Inverse</li> </ul>	Normal
DPM Mode	<p>use this setting when scanning Direct Part Marking (DPM) bar codes that are etched or imprinted directly into the surfaces of the materials including metal and plastic.</p> <p>Options include:</p> <ul style="list-style-type: none"> <li>• No DPM optimization</li> <li>• Dotpeen DPM decoding</li> <li>• Reflective DPM decoding</li> </ul>	No DPM optimization
Region of Interest	<p>Set the ROI for decoding. Options include:</p> <ul style="list-style-type: none"> <li>• Disable ROI is disabled and the entire original image is sent to the decoder.</li> <li>• Standard Use the aimer position to weight activity. Activity calculated on the row and the column in the middle of each cell. The ROI window may not include the aimer.</li> <li>• Standard, aimer centered Activity calculated on the row and the column in the middle of each cell. The ROI window will always include the aimer.</li> <li>• DPM, aimer centered Activity calculated on 4 rows and 2 columns in each cell. The ROI window will always include the aimer.</li> <li>• Kiosk/presentation application Ignore aimer position, no weight activity. Activity calculated on the row and the column in the middle of each cell. The ROI window may not include the aimer.</li> </ul>	Disabled

## Imager Settings

You should not need to modify the Imager Settings. The **Override Recommended Values** setting is disabled by default. The recommended Imager Settings are designed to work in a wide range of environments and should only be modified if you have an advanced understanding of imagers.

## Trigger Settings

Use the Trigger Settings to configure how the scan buttons work.



## Trigger Settings

Setting	Description	Default
Enable Scan Trigger	Enable or Disable activating the imager by pressing the side scan buttons or the virtual Scan button in the Scan Demo app.	Enabled
Scan delay	Set the minimum amount of time in seconds before the scanner can read another bar code.	0
Decode Timeout	Set the number of seconds before the scanner automatically turns off if the scan button is pressed and nothing has successfully decoded.	20
Trigger Scan Mode	Set read behavior on scan button press. Options available: <ul style="list-style-type: none"> <li>• One Shot</li> <li>• Continuous</li> <li>• Read on release</li> <li>• Read on second trigger press</li> </ul>	One Shot
Same symbol timeout	Set the minimum buffer time in seconds before the scanner reads the same bar code. This can be adjusted to prevent inadvertent scans of the same bar code if the code is left in the scan field longer than the Decode Timeout limit. The default same symbol timeout is 1000 seconds.	Disabled

## Notification Settings



Use the Notification Settings to configure how your computer responds when you scan a bar code.

### Notification Settings

Setting	Description	Default
Good Read Notification	Enables or disables a good read notification. The notification consists of a green blink of the Scan Status LED, a short beep, and an optional short vibration.	Enabled
Bad Read Notification	Enables or disables notification of a failed scan. The notification consists of a red blink of the Scan Status LED, an error beep, and an optional short vibration.	Disabled
Vibrate On Notification	Enables or disables whether the computer vibrates when there is a good or bad read.	Disabled

## Add a Scan Setting Profile

To create a scan setting profile for a custom app on the computer:

1. Swipe up from the bottom of the Home screen to access all apps.
2. Tap **Settings**  > **Honeywell Settings** > **Scanning** > **Internal Scanner**.
3. Tap  in the upper right corner of the app screen.

4. Take one of the following actions:

- Tap the profile name field, and then add a new name.

OR

- Tap the **select an application** option, and then choose an app from the list.

The new profile appears on the Internal Scanner profile list. You can now select and modify the scan settings for the new profile.

## Delete a Scan Setting Profile

1. Swipe up from the bottom of the Home screen to access all apps.
2. Tap **Settings**  > **Honeywell Settings** > **Scanning** > **Internal Scanner**.
3. Tap and hold the profile you want to delete.
4. Select **Delete**, then select **OK**.

## About the Optional Digital Scan Button

By default, the imager is enabled for scanning with the left, middle and right scan buttons configured to trigger the imager. If your application environment requires use of an on-screen scan button, enable the Digital Scan Button feature in the Settings app. Once enabled, you can then modify the appearance of the on-screen Scan button and select the apps the button appears in.

## Enable and Configure the Digital Scan Button

1. Swipe up from the bottom of the Home screen to access all apps.
2. Tap **Settings**  > **Honeywell Settings** > **Digital Scan Button**.
3. Tap **Enable Digital Scan Button** to turn the feature on. A preview of the button appears at the bottom of the screen.
4. Configure the button appearance. As you adjust the settings, the preview button updates.
  - Tap **Select Button Size**, and then choose Small, Medium or Large.
  - Tap **Select Button Color** and then choose from seven color options. Default color is black. Tap a dot to select the color, and then select **OK** to confirm.
  - Use the slider under **Set Transparency Level** to adjust how transparent the button appears on the application screen.
5. Drag the preview button to the location where you want it to appear on the screen. Once you have positioned the button, tap the **Set Button Location** toggle button to lock it into position.

6. Tap **Choose Application**.
7. Check the box next to all the applications where you want the digital scan button to be available.
8. Select **OK**.
9. Tap **Back** to return to the Settings screen.

The digital scan button appears on the screen when you open any of the apps you selected during the button setup. Tap and hold the button to activate the imager and scan a bar code.

## Scan Bar Codes

By default, the computer imager is enabled for scanning. It supports omni-directional (360°) bar code scanning and an aiming beam is provided to help assist with targeting bar codes.

Before you start scanning bar codes, go into **Settings > Honeywell Settings > Scanning > Internal Scanner** and modify the scan profile to enable only the bar code symbologies that you need. By reducing the active symbology list, you can increase scan speed.

1. Point the scanner window at the bar code. For optimum performance, avoid reflections by scanning the bar code at a slight angle.
2. Press and hold any **Scan** button.
3. Center the aiming beam over the bar code. Make sure the entire bar code is inside of the illumination frame.

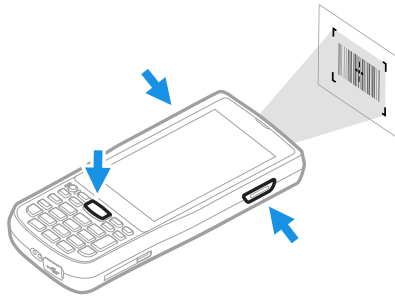

4. Release the **Scan** button when the computer beeps, and the Scan Status LED briefly turns on. The bar code information is entered into the application in use.

**Note:** *Not all bar code symbologies are enabled by default. If a bar code does not scan, the correct symbology may not be enabled.*

## About Scanning Configuration Bar Codes

After completing the out-of-box set up process, Provisioning mode is automatically turned Off. Scanning a bar code to install applications, certificates, configuration files, and licenses on the computer is restricted unless you enable Provisioning mode in the Settings app.

To learn more [About Provisioning Mode](#) see [page 70](#).

## Use the Scan Demo App

Use the Scan Demo app to read bar codes, or to test your symbology decode settings.

1. Swipe up from the bottom of the Home screen to access all apps.
2. Tap **Demos**.
3. Swipe left or right on the screen until **Scan Demo** appears under the turntable. Tap the center of the box image to open the app.
4. Point the scanner window at the bar code.
5. Press and hold any **Scan** button or tap and hold the on-screen Scan button.
6. Center the aiming beam over the bar code. Make sure the entire bar code is inside of the illumination frame.
7. Release the **Scan** button when the computer beeps, and the Scan Status LED briefly turns On. Bar code information appears on the screen.

**Note:** *In the Scan Demo app, not all bar code symbologies are enabled by default. If a bar code does not scan, the correct symbology may not be enabled.*

## Change the Scan Demo Symbology Settings

1. In the Scan Demo app, tap  in the upper right corner of the screen.
2. Select **Symbology Settings**.
3. Modify the symbology parameters.
  - Tap the check box next to a symbology name to enable (check mark) or disable (no check mark) decoding for that symbology.
  - Tap the symbology name to view and modify additional configuration parameters for the symbology selected.
4. Tap **Back** to return to the Scan Demo app.

# USE THE PHONE

You can use the phone feature to make and receive phone calls as well as transmit data through wireless wide-area networks (WWANs).

**Note:** Phone features are only supported on EDA51K WWAN models (EDA51K-1).

## About the Phone

Phone features on the computer include a speaker and microphone. You can also use a Bluetooth headset or hands-free kit.

On EDA51K WWAN models the phone feature is enabled by default and supports cellular radio access technologies (2G, 3G, etc.) for voice and data connections around the globe. See the EDA51K Data Sheet available for download at [www.honeywellaidc.com](http://www.honeywellaidc.com) for more information.

After you turn on the phone and activate service with your wireless carrier, you can customize the phone features and network settings in the Network & internet section of the Settings app.

**Note:** EDA51K WWAN models (EDA51K-1) support Network Information and Time Zone (NITZ) messages to automatically set the system time.

## Activate the Phone

You use a SIM card to activate the phone on your EDA51K WWAN model computer (EDA51K-1). You can purchase the micro SIM card from your network provider.

1. Press and hold the **Power** button until the options menu appears.
2. Tap **Power off**.
3. Remove the battery cover and battery from the computer, refer to [page 5](#).

4. Lift up the edge of the SIM card access door.

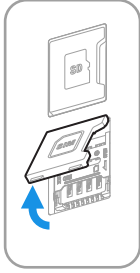

5. Press down gently and slide the card holder into the unlocked position. Lift the edge of the card holder up.

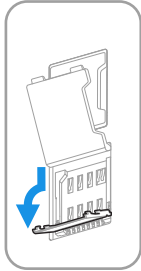

6. Insert the card in the holder with the contacts facing out, away from the holder.

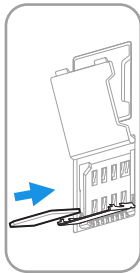



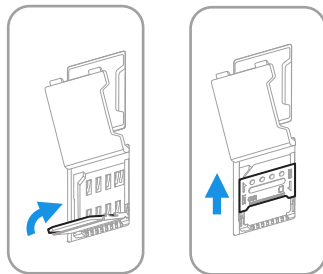



7. Close the holder with the card installed. Press down gently on the holder and slide it into the locked position.



8. Close the SIM card access door.
9. Insert the battery, install the battery door and engage the lock, see on [page 7](#).
10. Press the **Power** button.

# Make a Phone Call

Once the phone is activated, you can make a phone call.

1. Tap  in the favorites tray.
2. Use one of the methods below to enter the telephone number you want to call.
  - Tap  and use the on-screen dialer.
  - Select a person on your saved contact list .
  - Select a favorite on your speed dial list .
  - Select a number from the recent calls list .
3. Tap call .
4. To end the call, tap .

# Answer the Phone

When you receive a phone call, the Incoming Call screen opens. If the caller telephone number is available, it appears on the screen. Depending on your calling plan, you may also see a Caller ID information. All incoming calls are recorded in the Recent call log. If you miss a call, you receive a notification.

On the Incoming Call screen, when the lock screen is activated:

- Swipe up on the screen to answer the call.
- Swipe down on the screen to reject the call and send it to voicemail.
- Tap the message icon  to send a text message response to the caller instead of answering.

If your phone is already unlocked, a notification appears on the screen for the incoming call and you have the choice to select **Answer** or **Ignore**.

## Switch Apps During a Phone Call

You can multi-task while a phone call is in progress. For example, you can use the Calendar app to check your schedule during a call.

**Note:** *Depending on your WWAN connection and carrier, apps that need a data connection may be unable to access online data while the phone call is in progress. If simultaneous phone calls and data connections are not possible due to provider limitations, voice calls receive priority. Check with your provider for more information.*



1. During a phone call the screen goes dark. Take the phone away from your ear to wake the screen. Tap the **Home** button.
2. Select another app (e.g., Calendar, Contacts). The phone icon appears in the status bar at the top of the screen while the call is connected.
3. To return to the call screen, swipe down from the top of the screen and select ongoing call notification or select **Hang up** if you want to end the call.

## Make an Emergency Phone Call

You can use the phone to make an emergency phone call even if the SIM card is missing from your phone. The phone shows no service but the call still goes through if you dial certain emergency numbers (e.g., 112, 911, 000, 08, 118, 119, and 999).

## Configure Phone Settings

You can customize settings for the phone, including the ringtone, voicemail options, keypad tones, Internet call settings, and other options.

1. Open the phone app .
2. Tap  next to the microphone icon at the top of the screen.
3. Select **Settings**. The Call settings menu appears.
4. Change phone settings as necessary.

**Note:** *Available settings vary depending on your cellular carrier and phone plan.*



Use this chapter to learn how to take pictures and record videos with the color camera.

**Note:** *Due to model and software version differences, screen images and features included in this chapter may vary from what you see on your device.*

## About the Color Camera

The EDA51 comes equipped with a 13-megapixel color camera, 1080P video with image stabilization, and advanced software features for enhanced exposure control for taking pictures and videos. The camera lens and flash are located on the back of the computer.

Use the **Snapdragon™ Gallery** to view photos and videos stored on the EDA51. By default the photos and videos captured with the Camera app are saved on the computer under Internal shared storage\DCIM\Camera.

## How to Zoom

The camera zoom is controlled using a pinching motion on the touch screen. Place two fingers on the screen at the same time, and then:

- spread them apart to zoom in (enlarge and object), or
- pinch them together to zoom out.







## Take a Photo



1. Tap the **Camera** icon  in the favorites tray on the Home screen.
2. Using the screen as a viewfinder, move the computer until you see the image you want to capture. The camera lens is located on the back of the computer.

3. The camera automatically adjusts the focus, but you can tap the screen to modify the focal point. By default, the camera senses the lighting in the environment and turns the flash on, if needed.
4. Tap  or the Volume button to take a photo.
  - To view the picture, tap the preview near the bottom of the screen.
  - To return to the Camera app, tap the **Back** navigation button.

## Record a Video

This section explains how to record video with the camera in the computer.

1. Tap the **Camera** icon  in the favorites tray.
2. Tap  to start recording video.
  - To zoom in or out, pinch or spread your fingers apart.
  - To toggle sound recording on or off, tap the microphone icon at the top of the screen.
  - To pause recording, select . To resume recording, tap .
  - To capture a still picture during recording, tap the **Camera** icon .
  - To add light while recording, tap the flash icon.
3. When you are done recording, tap .

To access the video settings in the Camera app, select the more settings icon , and then the advanced settings  icon.

## Change Camera Settings

You can change the camera settings for best results when taking pictures. The camera settings are adjustable from within the Camera app.

1. Open the **Camera** app .
2. At the top of the screen, select any of the following to adjust the settings.



- **More Settings**  
Select to access Automatic Mode, HDR Mode and Advanced settings.

#### **Advanced Settings**

Select the gear  to access settings that allow you to modify the camera setting defaults and to configure how the camera app functions (i.e., General, Still camera, Video camera, and System).

- **Color Filters**  
Stylize your pictures by applying a filter. Options include: None, Mono, Sepia, Negative, Solarize, Posterize, and Aqua.
- **Flash Setting**  
Select to adjust the camera flash setting (e.g., automatic, no flash or always flash). This option is only available for the rear camera.

## Use the Camera as a Flashlight

To use the camera as a flashlight.

1. Open Quick Settings (see page [27](#)).
2. Tap the **Flashlight** icon to turn the flashlight on.
3. Select the icon again to turn the flashlight off.



# CONFIGURE THE COMPUTER

Use this chapter to learn about the available methods for configuring your mobile computer. You can also use this chapter to learn how to configure network communications and wireless security.



## How to Configure the Computer

You can configure many parameters on the computer such as the bar code symbologies the network settings. The values you set for these parameters determine how the computer operates.

You configure the computer using the Settings app.

### Start the Settings App

The Settings app is available from the all apps menu and the notification panel.

- Swipe up from the bottom of the Home screen, and then tap **Settings** .
- OR
- Swipe down from the top of the Home screen twice, and then select .

### About the Structure of the Settings App

Use this section to learn about the structure of the Settings app so you can find parameters quickly. A search field appears at the top of the screen when you open the Settings app to help you locate settings quickly.

**Note:** *The Settings app varies by computer model and OS version. Your computer may not include all the features outlined in this section.*

## Network & Internet

In the **Settings** app, select **Network & internet** to access the following settings.

Setting	Description
Wi-Fi	<ul style="list-style-type: none"> <li>• Turn WLAN radio On or Off.</li> <li>• Lists available Wi-Fi networks in range and the connection status when the radio is turned On.</li> <li>• Add a network Wi-Fi connection and view saved networks.</li> <li>• Tap Wi-Fi preferences to access advanced Wi-Fi options, view MAC, IP address information, import and export Wi-Fi configuration, Wi-Fi Direct, WPS push Button, WPS pin entry, Wi-Fi Logger, Honeywell Proprietary Settings, Open network notification and Install Certificates.</li> </ul>
Mobile Network (EDA51K-1 WWAN Models only)	<p>Modify mobile network settings, including enabling data access and roaming over mobile networks, selecting access points and network operations, or selecting only 2G networks to save battery life).</p> <ul style="list-style-type: none"> <li>• Turn Mobile data On or Off</li> <li>• Turn Roaming On or Off</li> <li>• View Data use information</li> <li>• Access advanced options, including: <ul style="list-style-type: none"> <li>• 4G LTE Mode on/Off setting</li> <li>• Preferred network settings</li> <li>• CDMA roaming settings and subscription settings (i.e. RUI/SIM, NV)</li> <li>• Access point name and selection</li> <li>• Network selection settings</li> </ul> </li> </ul>
Data Saver	Enable Data Saver to reduce data usage. When turned on, the feature limits how and with what frequency some apps send and receive data in the background.
Hotspot & tethering	<ul style="list-style-type: none"> <li>• Enable or disable USB tethering or Bluetooth tethering for sharing mobile data connections.</li> <li>• Enable or Disable using the computer as a portable Wi-Fi hotspot.</li> <li>• Configure Wi-Fi hotspot.</li> </ul>
Mobile plan (EDA51K-1 WWAN Models only)	Provides information on your cell phone plan.
Advanced	
Data usage	<ul style="list-style-type: none"> <li>• Manage mobile/cellular data usage.</li> <li>• View mobile or Wi-Fi data use statistics for the current data use cycle.</li> <li>• Turn network restrictions for metered WLAN networks on or off.</li> </ul>
Airplane Mode	Turn Airplane mode On or Off.
VPN	Set the password parameters for a Virtual Private Network (VPN) connection.
Private DNS	Select Private DNS Mode (e.g., Off, Automatic, Private DNS provider hostname).

## Connected Device

In the **Settings** app, select **Connected devices** to access the following settings.

Setting	Description
Pair new device	<ul style="list-style-type: none"> <li>• Connect to a Bluetooth Device.</li> <li>• Lists Bluetooth enabled devices in range.</li> <li>• View and rename the computer.</li> <li>• View the computer Bluetooth address.</li> </ul>
Previously connected devices	View previously connected devices. When devices are currently connected they appear at the top of the screen.
Connection Preferences	
Bluetooth	<ul style="list-style-type: none"> <li>• Turn the Bluetooth radio On or Off.</li> <li>• Lists Bluetooth enabled devices in range when the radio is turned On.</li> <li>• Connect to a Bluetooth Device.</li> <li>• View and rename the computer.</li> <li>• View the computer Bluetooth address.</li> </ul>
NFC	Turn Near Field Communication (NFC) On or Off. When the NFC radio is enabled, data exchanges are allowed when the computer touches another NFC enabled device.
Android Beam	Turn the Android Beam feature On or Off. When NFC is enabled, this feature is accessible. You can beam app content to another NFC capable device by holding the devices close together. The app determines what content is transmitted to the other device.
Cast	Set up a Cast connection. Cast (project) audio and screen content to a secondary device such as a television.
Printing	Set up a printer connection with the mobile computer. Connection options include cloudprint services, Wi-Fi printing via a router or printing via NFC.
Files received via Bluetooth	View statistics and received files via Bluetooth wireless technology.

## Apps & Notifications

In the **Settings** app, select **Apps & notifications** to access the following settings.

Setting	Description
Apps	To view a list of all apps installed on the computer and system services running, select "SEE ALL xx APPS" where xx = number of apps installed.
Notifications	Select to manage notifications. <ul style="list-style-type: none"><li>Viewing statistics on recent app notifications.</li><li>Set rules for notifications on the screen lock.</li><li>Under Advanced:<ul style="list-style-type: none"><li>Turn notification snoozing on or off.</li><li>Turn Suggested actions and replies on or off.</li><li>Turn notification dots on or off.</li><li>Set the default sound for all notifications.</li><li>Set Do Not Disturb parameters or manually turn the Do Not Disturb on or off.</li></ul></li></ul>
Default apps	Select to view and manage default app use.
Permissions manager	Select to view and manage individual app permissions.
Advanced	
Special app access	Manage apps with special unrestricted access.

## Battery

In the **Settings** app, select **Battery** to view battery status, use statistics and adjust features that conserve battery charge.

Setting	Description
Battery	View current battery charge or charging status at the top of the screen.
Battery saver	Select to configure the Battery Saver feature. <ul style="list-style-type: none"><li>Manually turn the Battery Saver on to restrict background activity to extend battery charge or turn the feature off.</li><li>Set a schedule to turn the Battery saver feature on or off automatically based on remaining battery charge percentage. When schedule is enabled, adjust the slider to indicate at what percentage the Battery Saver feature should automatically activate. You can choose anywhere between 5% to 75%.</li><li>Set the Battery Saver feature to automatically turn off when your computer battery charge is above 90%.</li></ul>
Battery Manager	Turn the Battery Manager feature on to receive notifications applications draining above average battery power.
Battery percentage	Set to show or do not show battery percentage in status bar.
Last full charge	View time since the battery was fully charged.
Screen usage since full charge	View amount of time when the screen was used since the battery was fully charged.



## Display

In the **Settings** app, select **Display** to access the following settings.

Setting	Description
Brightness level	Set the Brightness level manually if the Adaptive brightness feature is turned Off.
Night light	Activate the Night light feature to adjust the screen tint to a light amber for easier viewing and reading in dim light or for the hours you use the device before going to sleep. Set the feature to stay on or define a schedule to automatically turn the feature on or off. You can manually adjust the intensity of the amber hue once the feature is activated.
Adaptive brightness	Set how the screen in sleep mode responds when new notifications are received (e.g., wake or do not wake).
Wallpaper	Set the wallpaper.
Dark theme	Turn Dark theme on or off.
Advanced	
Screen timeout	Set the inactivity time limit before the unit automatically turns off the screen to save battery power (seconds or minutes). Also known as sleep mode.
Auto-rotate screen	Set the screen to switch from portrait to landscape when the unit is rotated. When turned off, the screen does not automatically rotate.
Font size	Set the default on-screen text size.
Display size	Set the default size of items on your screen.
Screen saver	Select to configure the screen saver. <ul style="list-style-type: none"><li>Set a default screen saver (i.e., Clock, colors, Photo Frame, Photo Table). The additional settings icon appears based on the selected screen saver type. Select the icon to view options.</li><li>Set when the screen saver activates (e.g., While charging, While docked, While charging and docked or Never).</li><li>Select Start Now to enable the feature.</li></ul>
Lock screen display	Select to configure what shows and what can be done when the screen lock is activated. <ul style="list-style-type: none"><li>Choose to show or not show notifications.</li><li>Enable or restrict adding users from the lock screen.</li><li>Add a custom message to the lock screen.</li><li>Set the screen to wake or not wake when a notification is received.</li></ul>

## Sound

In the **Settings** app, select **Sound** to modify the audio and sound settings. To learn more, see [Audio/Sound Settings](#) on page 15.

## Storage

In the **Settings** app, select **Storage** to view statistics on available and used storage space on the device and on any portable storage cards installed.

## Privacy

In the **Settings** app, select **Privacy** manage permissions, account activity and personal data.

Setting	Description
Permissions manager	Manage personal data sharing privileges.
Show passwords	Enable or disable showing characters briefly as you type.
Lock Screen	Choose to show or not show notifications content on the Lock screen.

## Location

In the **Settings** app, select **Location** to access the settings below.

Setting	Description
Use location	Turn location services (Google and GPS satellite data) on or off.
Recent Location Requests	View location request history.
App permissions	View what apps have what type of permission for accessing the mobile computer's location. Select an app to change the app-level location service permission. <ul style="list-style-type: none"><li>• Allow all the time</li><li>• Allow only while using the app</li><li>• Deny</li></ul>
Wi-Fi and Bluetooth scanning	Turn Wi-Fi and/or Bluetooth scanning on or off. When enabled system apps and services are allowed to detect Wi-Fi networks or Bluetooth devices at any time to improve location services.

## Security

In the **Settings** app, select **Security** view latest Security scan results, security updates and phone encryption status. Access additional settings related to device security.

Setting	Description
Screen Lock	Activate and configure a screen lock (i.e., None, Swipe, Pattern, Pin, Password).
Device admin apps	Manage administrator privileges.
Encryption & credentials	Select to view encryption status and manage credentials (e.g., view, install, clear, and edit). <ul style="list-style-type: none"><li>• Trusted credentials</li><li>• User credentials</li><li>• Install from storage</li><li>• Clear credentials</li></ul>
Trusted agents	View and enable/disable trusted agent apps such as, Smart Lock by Google on the device. Trusted agents bypass security based on set parameters.

Setting	Description
Screen pinning	Enable or disable the screen pinning feature. When enabled you can pin the device screen to a recently used app where it stays until you unpin the app via the security method chosen.

## Accounts

In the **Settings** app, select **Accounts** to access the following settings.

Setting	Description
Add account	Select to add and manage Corporate or Email account on the computer.
Automatically sync data	Turn auto-sync On or Off for accounts. Turning the feature On allows apps to refresh data automatically.

## Accessibility

In the Settings app, select **Accessibility** to access screen readers, display settings, interaction controls, and audio & on-screen text features to improve accessibility levels.

Setting	Description
Volume Key Shortcut TalkBack	When turned on, the feature provides spoken feedback so you can use the computer without always looking at the screen. TalkBack describes your actions and tells you about alerts and notifications
Downloaded Services	
ScanWedgeAccessibility	<p>Enable or Disable ScanWedgeAccessibility service. This feature is turned off by default. When the feature is turned on you are asked to allow the ScanWedgeAccessibility service to have full control of your device so the service can:</p> <ul style="list-style-type: none"> <li>View and control screen The service can read all content on the screen and display content over other apps.</li> <li>View and perform actions The service can track your interactions with an app or a hardware sensor, and interact with apps on your behalf.</li> </ul> <p>For example, when the ScanWedgeAccessibility service is on, quick pairing with another Bluetooth device by scanning barcode is enabled.</p>
Screen Readers	
Text-to-speech output (TTS)	Select and configure the preferred TTS, set language, speech rate and pitch of synthesized voice.

Setting	Description
Display	Configure display features that may aid visual accessibility levels. <ul style="list-style-type: none"> <li>Adjust Font size.</li> <li>Adjust Display size.</li> <li>Turn Dark theme on or off.</li> <li>Turn the Magnification feature on or off.</li> <li>Set Color correction.</li> <li>Turn Color inversion on or off</li> <li>Turn Large mouse pointer on or off.</li> <li>Turn Remove animations on or off.</li> </ul>
Interaction controls	Set interaction controls that may aid physical accessibility levels. <ul style="list-style-type: none"> <li>Set the Dwell timing delay (i.e., click after pointer stops moving).</li> <li>Turn Auto-rotate screen on or off.</li> <li>Adjust the Touch &amp; hold delay.</li> <li>Adjust the Time to take action (Accessibility timeout) delay. This adjusts how long temporary action messages appear on the screen.</li> <li>Accessibility Menu provides large on-screen menus.</li> <li>Turn Vibration &amp; haptic feedback on or off for Ring tone, Notifications, Touch.</li> </ul>
Audio & on-screen text	<ul style="list-style-type: none"> <li>Turn Mono audio on or off.</li> <li>Adjust Left and Right audio balance.</li> <li>Set Caption preferences.</li> </ul>
High contrast text	Turn High contrast text on or off.

## Honeywell Settings

In the **Settings** app, select **Honeywell Settings** to access the settings below.

Setting	Description
Battery LED	Configures the battery LED behavior. To learn more, see <a href="#">Change the Battery LED Status Behavior</a> , page 9.

Setting	Description
Battery Optimizer	<p>View battery status and app usage information.</p> <p>Select Status to choose a preset profile or create a custom battery optimization profile that implements a group of settings to conserve power. Options include:</p> <ul style="list-style-type: none"> <li>• None When selected, no battery optimization profile is active.</li> <li>• Energy Saver This pre-defined profile implements UI settings that optimize battery conservation.</li> <li>• Cold Storage This pre-defined profile implements UI settings that optimize battery conservation in cold storage environments.</li> <li>• Custom Profile Select to create a custom battery profile that balances your application needs with energy saving settings. You can turn location services on or off, configure sound and vibration options, modify brightness and timeout display options, turn UI transition animations on or off, and background services on or off.</li> </ul>
Digital Scan Button	<p>Enable and configure the optional digital scan button. To learn more, see <a href="#">About the Optional Digital Scan Button</a> on page 40.</p>
Glove mode	<p>Enable or disable Glove mode.</p>
HXLogger	<p>The HXLogger is an advanced diagnostic log service that provides a basic log service, plugins for modified log services, and a log manager. When enabled, the service records app and system diagnostic troubleshooting information in four basic log files: main log, radio log, event log, and kernel log.</p> <ul style="list-style-type: none"> <li>• Select <b>HXLogger</b> toggle switch to turn the basic log service on or off. To change the maximum number of bootset folders, tap , and then select the maximum <b>BootSet</b> folder count. Tap <b>OK</b>.</li> <li>• Select <b>Plugin</b> to view and enable additional log services and custom plugins. Select a plug name, and then use the toggle switch to turn it on or off. Modify the plugin settings once enabled.</li> <li>• Select <b>Manager</b> to change the default log path, delete logs, or upload logs for technical support troubleshooting. To change the log path, tap <b>Change log path</b> then select an available path. Tap <b>OK</b>. To delete log files, press and hold a log name. Check boxes appear. Select the box for each log file to delete, and then tap the trash can icon.</li> </ul>
Key WakeUp	<p>Set the buttons you want to use to wake the computer from time out (sleep) mode. To learn more see, <a href="#">Key WakeUp</a> on page 26.</p>
Key Remap	<p>Change (remap) a button function. To learn more, see <a href="#">Remap a Button or Key</a> on page 24.</p>
Provisioning Mode	<p>Enable or disable unrestricted installation of applications, certificates, configuration files, and licenses. Provisioning mode is turned off by default. To learn more <a href="#">About Provisioning Mode</a>, see page 70.</p>
ScanHandleService	<p>Enable or Disable Scan handle, see <a href="#">About the Optional Digital Scan Button</a> on page 40.</p>

Setting	Description
Scanning	Configure the computer imager. To learn more, see <a href="#">Change the Scanner Settings</a> on page 34.
Smart Sensors	Configures the integrated motion detection sensors for advanced power management. Options include: Keep awake on motion, Wake on motion, Face down suspend.
Staging Hub Agent	Use this agent and settings to connect the computer to the Honeywell Staging Hub Foundation software platform; a centralized software platform IT integrators and administrators can use as a solution for managing, monitoring and deploying Honeywell devices in a connected workspace environment. See the Staging Hub Foundation online help for information on setting up Staging Hub and managing connected devices.
Web Applications	Enables access for the Honeywell Mobility SDK for Web apps and lets you set a port.

## System

In the **Settings** app, select **System** to access the following settings.

Setting	Description
Language & input	<ul style="list-style-type: none"> <li>• Set the Device Language</li> <li>• Set and manage the Virtual and Physical keyboard input methods</li> <li>• Under Advanced configure the: <ul style="list-style-type: none"> <li>• Spell checker</li> <li>• Autofill service</li> <li>• Personal dictionary</li> <li>• Pointer speed</li> </ul> </li> </ul>
Gestures	<p>Enable, disable and configure button shortcuts.</p> <ul style="list-style-type: none"> <li>• Jump to camera by pressing the power button twice.</li> <li>• Prevent ring (Vibrate or Mute) by simultaneously pressing the Power &amp; Volume up button.</li> </ul>
Date & time	Configure all date, time and time zone settings.
Backup	Turn the Google Drive backup feature on or off. When enabled, phone data (e.g., apps, apps data, call history, contacts, device settings, SMS, Wi-Fi passwords and permissions) is automatically backed up to the Google Drive.
Advanced	

Setting	Description
Reset Option	<p>Select from the following reset options:</p> <ul style="list-style-type: none"> <li>Reset Wi-Fi, Mobile &amp; Bluetooth. Use to reset all network settings, including Wi-Fi, Mobile data and Bluetooth.</li> <li>Reset app preferences. Use reset app preference back to defaults. This apps you disabled, notification changes, default app actions set, background data restrictions for apps and permission restrictions.</li> <li>Enterprise data reset. To learn more, see <a href="#">About an Enterprise Data Reset</a> on page 75.</li> <li>Erase all data (factory reset). To learn more, see <a href="#">About Full Factory Reset</a> on page 76.</li> </ul>
Multiple Users	<ul style="list-style-type: none"> <li>Modify the owner profile name and add profiles for other people who use the computer.</li> <li>Activate a different user profile.</li> <li>Enable or disable allowing users to be added from the lock screen.</li> </ul>
Developer options	<p>Enable developer-specific options such as USB debugging and SD card protection.</p> <p>This option only appears under System settings if you enable to feature. To learn more, see <a href="#">Unlock Developer Options</a> on page 32.</p>

## About Phone

In the Settings app, select **About Phone** to access the following settings.

- View device-specific information including the model number, phone number, operating system version, software patch version, radio versions, build number, IP address, Wi-Fi MAC, Bluetooth Address and legal information.

## About Network Communications

You can easily add the computer to your WWAN or wired data collection network. Connect the EDA51 your computer using:

- Mobile network
- 802.11 a/b/g/n/ac radio communications
- Bluetooth communications
- USB and serial communications

## Connect to Mobile network

Mobile network only supported on EDA51K-1 WWAN version. Before using mobile network, need to insert activated local carrier's Nano SIM card.



- Enter **Settings > Mobile network > Mobile Data**.
- Tap **Mobile Data** to on (Default status is on).

3. Using the mobile computer transfer data through local carrier's network.

## Connect to a Wi-Fi Network

The computer contains an 802.11 a/b/g/n/ac radio to transfer data using WWAN communications. Before you connect to a Wi-Fi network, you need to know about your network security protocol and its required credentials.

By default, the 802.11 radio is disabled.

1. Swipe up from the bottom of the Home screen to access all apps.
2. Tap Settings  > **Network & Internet** > **Wi-Fi**.
3. Tap **Off**  to toggle Wi-Fi radio **On** . A list of discovered networks appears.
4. On the list, tap a network name to initiate a connection.

To add a network if it does not appear on the list:

- a. Navigate to the end of the discovered network list, and then tap **Add network**.
  - b. Type the Wi-Fi network name (SSID).
  - c. Choose a security protocol and add any required information.
  - d. Tap **Save**.
5. Enter any required information if the network is secured (e.g., password, key or certificate name).
  6. Tap **Connect**.

Once you connect to a saved Wi-Fi network:

- Tap the network name on the list to view details (e.g., status, signal strength, speed, frequency, security type). Select **Cancel** to close details screen.
- The computer automatically connects to the same network when the network is in range and the WLAN radio is turned On.
- To remove a network from your saved list, tap and hold the network name and select **Forget network**. You can do this for networks you no longer use.
- To modify a network from your saved list, tap and hold the network name and select **Modify network**. You can do this if you changed your network password.
- To view a list of only your saved networks, tap , and then select **Saved networks**.



## Configure Proxy Settings for a Wi-Fi Network

If you need to connect to network resources through a proxy server, you can configure settings for the proxy server for each Wi-Fi network you add. By default, the Wi-Fi networks you add are not configured to connect through a proxy server.

**Note:** Proxy settings apply only to the Wi-Fi network you modify. You must change proxy settings for each network requiring a proxy server.

1. Swipe up from the bottom of the Home screen to access all apps.
2. Tap Settings  > **Network & Internet** > **Wi-Fi**. The list of available Wi-Fi networks appears.
3. Tap and hold the name of a connected network, and then tap **Modify network**.
4. Tap **Advanced options**.
5. Under Proxy, tap **None** to open menu, and then select **Manual**.
6. Enter the proxy settings for the network.
7. Tap **Save**.

## Disable Wi-Fi Notifications and Set WLAN Radio Sleep Parameter

By default, when Wi-Fi is enabled, you receive notifications in the Status bar when the computer discovers a WWAN. You can disable these notifications.

1. Swipe up from the bottom of the Home screen to access all apps.
2. Tap Settings  > **Networks & Internet** > **Wi-Fi**. Verify the WLAN radio is turned On.
3. Select **Wi-Fi preferences**.
4. Tap **Open network notification** to toggle the setting On or Off.

## How to Connect to Virtual Private Networks

The computer supports connecting to virtual private networks (VPN). This section describes how to add and connect to VPNs. To configure VPN access, you must obtain details from your network administrator. You can view and change VPN settings in the Settings app.

**Note:** Before you can add or connect to a VPN network, you must enable a screen lock method.



## Add a VPN

Before you can connect to a VPN, you must create a VPN profile.

1. Swipe up from the bottom of the Home screen to access all apps.
2. Tap **Settings**  > **Network & internet** > **Advanced** > **VPN**.
3. Tap **+** to add a VPN new profile.
4. Enter the required information for the VPN connection. If needed, swipe up on the screen to access all the required information fields.
5. Tap **Save**. The VPN name appears in the VPN list.



## Connect to a VPN

Once a VPN profile is created, you can connect to the VPN at any time.

1. Swipe up from the bottom of the Home screen to access all apps.
2. Tap **Settings**  > **Network & internet** > **Advanced** > **VPN**.
3. Tap the name of the VPN in the list.
4. Enter any necessary credentials when prompted.
5. Tap **Connect**.  
A  appears in the status bar and a notification is received. To disconnect from the VPN, tap the notification.

## Edit VPN Information

Editing an existing VPN profile can be done from the VPN screen.

1. Swipe up from the bottom of the Home screen to access all apps.
2. Tap **Settings**  > **Network & Internet** > **Advanced** > **VPN**.
3. Tap and hold the name of the VPN in the list.
4. Tap  to the right of the VPN profile you want to edit.
5. Edit the VPN settings as necessary.
6. When you are done, tap **Save**.

## About WWAN Security

The computer provides these security solutions for your WWAN network:

- Wi-Fi Protected Access 2 (WPA2™)
- Wi-Fi Protected Access (WPA)

- 802.1x
- LEAP
- WEP

Honeywell recommends WPA2 security with PSK (Personal) or 802.1x (Enterprise) key management.

Before you set security, you need to enable the radio, set the date, and set the SSID on your computer. To use 802.1x security, you need to load a root certificate on your computer. To use transport layer security (TLS) with 802.1x security, you also need to load a user certificate.

Use the Settings app to access and configure all WWAN security settings.

## About Certificates

You can use digital certificates to identify the computer for network access or authentication to servers. To use a certificate to identify your device, you must install it in the trusted credential storage on the computer.

Android supports DER-encoded X.509 certificates saved in files with a .crt or .cer file extension. To install a valid certificate with a .der or other extension, you must change the extension to .crt or .cer to install it.

Android also supports X.509 certificates saved in PKCS#12 key store files with a .p12 or .pfx extension. To install a valid key store file with another extension, you must change the extension to .p12 or .pfx to install it. When you install a certificate from a PKCS#12 key store, Android also installs any accompanying private key or certificate authority certificates.

## Load a Certificate

To use a certificate, you must install it in the trusted credential storage on the computer.

**Note:** Apps such as email and browsers that support certificates allow you to install certificates directly from within the app. For more information, see the help that comes with the app.

1. Copy the certificate or key store from your PC to the mobile computer.
2. Swipe up from the bottom of the Home screen to access all apps.
3. Tap **Settings**  > **Security** > **Encryption & credentials**.
4. Tap **Install from storage**. Navigate to the location where you saved the certificate or key store.
5. Tap the certificate or key store to install it. If prompted, enter the key store password and tap **OK**.
6. Select **VPN and apps** or **Wi-Fi**.

7. Enter a name for the certificate and tap **OK**.

## Disable or Remove Certificates

If a user or system certificate is compromised, or your organization chooses not to trust it, you can disable or remove the certificate.

1. Swipe up from the bottom of the Home screen to access all apps.
2. Tap **Settings**  > **Security** > **Encryption & credentials**.
3. Select **Trusted credentials**.

The trusted credentials screen has two tabs:

- **System** shows Certificate Authorities (CA) certificates permanently installed on the computer. They can only be disabled.
  - **User** shows CA certificates you have installed yourself. You can remove these certificates.
4. Tap the name of the certificate to you want to disable or remove. The Security certificate screen appears.
  5. Scroll to the bottom of the screen and tap **Disable** (for System certificates) or **Remove** (for User certificates).
  6. Tap **OK**.

**Note:** You can enable a disabled System certificate but if you remove a User certificate, you must install it again to enable it.

## About Bluetooth Communications

Your mobile computer is equipped to communicate with other devices using Bluetooth technology. The Bluetooth radio must be turned On to discover, pair and connect to other Bluetooth devices. System bar icons indicate Bluetooth radio status.

To toggle the Bluetooth radio on or off, swipe down from the top of the screen and tap the Bluetooth icon  .

## Connect a Bluetooth Device

To connect to a Bluetooth device, you must turn on the Bluetooth radio and then select the device from a list of discovered devices.

1. Verify the Bluetooth radio is on.
2. Swipe up from the bottom of the Home screen to access all apps.
3. Tap **Settings**  > **Connected devices**.

4. Tap **Pair a new device**  . A list of available Bluetooth devices in range appears.
5. Select a device on the list to initiate a pairing request.
6. When the pairing request message appears:
  - Verify the pairing PIN is the same on both device, and then tap **Pair**.OR
  - If the pairing request requires a PIN, enter the **PIN**, and then tap **Pair**.
7. (Optional) Once paired to a device, you can connect manually to the device. Tap the device under Previously Connected Devices. The device shows under “Currently Connected” .

To disconnect a paired device, tap  next to the name of the paired device and then tap **Forget**.



## Rename the Computer and View File History

You can change the name of the computer to make it easier to identify when pairing with other Bluetooth enabled devices and view statistics about received files.

1. Swipe up from the bottom of the Home screen to access all apps.
2. Tap **Settings**  > **Connected devices** > **Connection preferences** > **Bluetooth**.
3. Tap **Device Name**. Type the new name and then select **Rename**.

## Rename, Share, or Unpair a Paired Device

You can rename a paired device to make it easier to identify on the list or unpair the device to remove it from the paired list.

1. Swipe up from the bottom of the Home screen to access all apps.
2. Tap **Settings**  > **Connected devices** > **Bluetooth**.
3. Tap  next to the **paired device**.
4. Take one of the following actions:
  - To rename the device, select the edit icon  . Type the new name, and then tap **RENAME**.
  - To allow **Internet connection sharing** or **Contact Sharing**, tap on/off toggle button next to the setting.
  - To unpair the device, tap **Forget**.

# About USB Communications

You can use these EDA51K accessories to transmit data to and receive data from another device through serial or USB communications:

- USB cable

## USB Troubleshooting

- If you have a problem with your workstation computer recognizing the USB device, try downloading and installing the Honeywell-aidc-usb-driver. The driver is part of the Honeywell\_Mobility SDK\_Android software.zip file. To learn where to get the software, see [Developer Information](#) on page 70.
- Check to make sure you have enabled the USB for file transfer. To learn more, see [Configure USB Connection and Transfer Files](#) on page 18.

# How to Share Your Mobile Data Connection

You can share the mobile data connection through USB tethering or Bluetooth tethering. You can also use the computer as a Wi-Fi hotspot to share the connection with other devices.

## Use Bluetooth or USB Tethering to Share a Data Connection

You can share your mobile computer data connection with another device through a USB tethering or Bluetooth tethering connection.

### Minimum requirements for USB Tethering

- The EDA51K must have an Android 10 OS or later.
- A EDA51K compatible USB communication accessory.

## Set up and Connection

1. Connect the USB cable to both devices.
2. On the EDA51K, swipe down twice from the top of the screen.
3. Select Android System twice.
4. Change the USB Preference setting from to **USB tethering**.
5. Tap **Settings**  > **Network & Internet** > **Hotspot & tethering**.

6. Select **USB tethering** to initiate the shared data connection.

**Note:** To stop sharing the connection, tap **USB tethering** again to turn Off the feature or disconnect the USB accessory.

## Minimum requirements for Bluetooth Tethering

- All devices must support Bluetooth communication.

## Set up and Connection

1. Pair the EDA51K with another Bluetooth enabled device.
2. Verify the other device is set to use a network connection using Bluetooth technology.
3. Swipe up from the bottom of the Home screen to access all apps.
4. Tap **Settings** > **Network & tethering** > **Hotspot & tethering**.
5. Select **Bluetooth tethering** to initiate the shared data connection.

**Note:** To stop sharing the connection, tap **Bluetooth tethering** again to turn Off the feature.

## About Near Field Communication (NFC)

NFC technology provides the ability for short-range, WWAN data transfer between the EDA51 and NFC tags or other NFC enabled devices placed in close proximity to the back of the computer. All EDA51 mobile computers support the following modes of operation:

- NFC tag reader/writer mode: The computer reads and/or writes digital information from or to an NFC tag.
- Peer-to-Peer (P2P) mode: The computer uses Android Beam and/or Bluetooth technology to transfer screen content (e.g., a picture, contact information, Web page URL, or file) between NFC enabled devices.
- NFC card emulation mode: The computer emulates an NFC card (smart card) that an external card reader can access. You can download and install apps for card emulation mode from the Google Play™ store. Some examples include digital wallets (e-wallets) offered by your bank or credit card company and Google Pay™. The app you install determines the type of emulation mode used: Card Emulation with a Secure Element or Host-based Card Emulation. Secure element use is common for financial transactions that require a high level of security in order to provide a secure memory and execution environment for running custom smart card applets and storing your personal information (e.g., account information and credentials).

**Note:** When using a Universal Integrated Circuit (UICC) card for NFC Secure Element NFC link encryption, install the card in SIM Nano SIM slot.

# Developer Information

To download the Honeywell Mobility SDK for Android and EZConfig for Mobility:

1. Go to [www.honeywellaidc.com](http://www.honeywellaidc.com).
2. Select **Resources** > **Software**.
3. Click on the *Technical Support Downloads Portal* link, <https://hsmftp.honeywell.com>.
4. Create an account if you have not already created one. You must login to download the software.
5. Install the *Honeywell Download Manager* tool on your workstation (e.g., laptop or desktop computer) prior to trying to download any files.
6. Navigate to the software:
  - *Honeywell Mobility SDK for Android*  
Click on **Software** > **Software and Tools** > **Developer Library** > **SDKs for Android**.
  - *EZConfig for Mobility*  
Click on **Software** > **Software and Tools** > **EZConfig for Mobility**.
7. Select **Download** next to the software zip file.

## About Provisioning Mode

Once you complete the out-of-box initial setup process, Provisioning mode is automatically turned Off to improve device security against unwanted modifications to the system.

When Provisioning mode is turned Off (disabled):

- Configuration bar codes do not scan and process.
- \honeywell\autoinstall folders are inaccessible.

**Note:** To learn more about network and security for Honeywell mobile computers with Android operating systems, go to [www.honeywellaidc.com](http://www.honeywellaidc.com).

## Enable or Disable Provisioning Mode

1. Swipe up from the bottom of the Home screen to access all apps.
2. Tap **Settings**  > **Honeywell Settings** > **Provisioning mode**.
3. Tap the button to toggle the provisioning **On** or **Off**.



# MANAGE AND MAINTAIN THE COMPUTER

Use this chapter to understand how to upgrade software, reset, and maintain the mobile computer.

## About Software Updates

Honeywell provides patches and security updates for existing software products at no additional charge. Software upgrades (from one major version to another) may involve additional charges. Some licensed software that Honeywell distributes requires user registration and log in before the software can be downloaded.

Support for Honeywell Safety and Productivity Solutions products is available online through the [Technical Support Portal](#).

Software downloads can be accessed through the [Technical Support Downloads Portal](#).



1. Go to [www.honeywellaidc.com](http://www.honeywellaidc.com).
2. Select **Resources** > **Software**.
3. Click on the *Technical Support Downloads Portal* link, <https://hsmftp.honeywell.com>.
4. Create an account if you have not already created one. You must login to download the software.
5. Install the *Honeywell Download Manager* tool on your workstation (e.g., laptop or desktop computer) prior to trying to download any files.
6. Locate the app or upgrade you want to download in the Software directory tree.
7. Select **Download**. Follow the prompts to download the file.

## About Transferring Files via USB Connection

If you plan on using a USB connection to transfer the upgrade files to the mobile computer, make sure you set the USB connection to allow file transfers. To learn more, see [Configure USB Connection and Transfer Files](#) on page 18.

# Install Software Updates with AutoInstall

**Important:** *The EDA51K must have power for the entire length of the upgrade process or it could become unstable. Do not attempt to remove the battery during the process.*

1. Swipe up from the bottom of the Home screen to access all apps.
2. Tap **Settings**  > **Provisioning mode** under *Honeywell Settings*.
3. Tap the toggle button to turn Provisioning mode **On**.
4. Save the upgrade file (\*.zip or \*.apk) in one of the following folders on the EDA51K mobile computer:
  - **Internal shared storage\honeywell\autoinstall**  
Software upgrades saved to this folder for installation, do not persist when a Full factory reset or Enterprise data reset is performed.
  - **IPSM card\honeywell\autoinstall**  
Software upgrades saved to this folder, do not persist when a Full factory reset is performed. However, the upgrade does persist if an Enterprise data reset is performed.
5. Swipe up from the bottom of the Home screen to access all apps.
6. Tap **AutoInstall Settings**  and verify **Autoinstall** is enabled .
7. Tap **Packages Update** from the AutoInstall Settings screen.



If required by the app, the computer may automatically initiate a reboot before starting the installation process. When the installation is finished, a message appears or the unit finishes rebooting and the lock screen appears.
8. Once installation is complete, turn Provisioning mode **Off**.

**Note:** *Some updates do not require the computer to restart before installation.*

## Optional microSD Card Method

The EDA51K comes equipped with a microSD card socket. You can install an upgrade from a microSD card you insert in the computer.

**Important:** *The EDA51K must have power for the entire length of the upgrade process or it could become unstable. Do not attempt to remove the battery during the process.*

1. On the EDA51K, swipe up from the bottom of the Home screen to access all apps.
2. Tap **Settings**  > **Provisioning mode** under *Honeywell Settings*.
3. Tap the toggle button to turn Provisioning mode **On**.
4. Tap **AutoInstall Settings** . Verify **AutoInstall** is enabled .

5. Press and hold the **Power** button, and then tap **Power off**.
6. On your workstation (e.g., laptop, desktop computer), format the microSD card and create a **\honeywell\autoinstall** folder on the root of the card.
7. Save the upgrade file in the **autoinstall** folder.
8. Install the microSD card in the EDA51K, and then press the **Power** button.

The computer automatically runs the upgrade found in the autoinstall folder on the card. The system update screen appears during the upgrade process. When the upgrade is finished, the lock screen appears.

9. Once installation is complete, turn Provisioning mode **Off**.

## About the Honeywell Upgrader

Use the Honeywell Upgrader app (HUpgrader) to check for and install OTA updates or view the current OTA version installed on the computer.

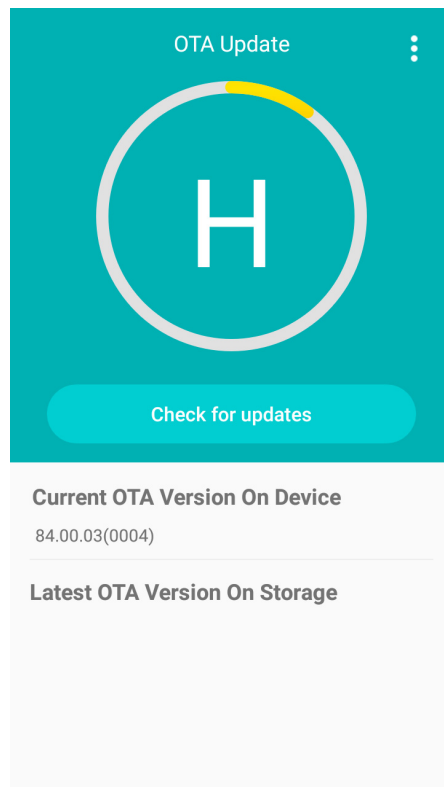

## How to view the Installed OTA Version

1. Swipe up from the bottom of the Home screen to access all apps.
2. Tap **HUpgrader**  to open the Honeywell Updater app. The OTA version number installed on the computer appears on the screen.



# Install OTA Updates

To use the HUpgrader to install an OTA update file downloaded from the [Technical Support Downloads Portal](#).

1. Swipe up from the bottom of the Home screen to access all apps.
2. Tap **Settings**  > **Provisioning mode** under Honeywell Settings.
3. Tap the toggle button to turn Provisioning mode **On**.
4. Save the OTA file (\*.zip) in the following folder on the EDA51K computer:
  - **Internal shared storage\Download**
5. Tap **HUpgrader**  to open the Honeywell Updater app.
6. Tap  in the upper right corner, and then tap **Select OTA from storage**.
7. Select the storage location (i.e., Internal Storage) where you saved the file.
8. Tap the OTA update file. The computer examines the file, and then starts the installation.

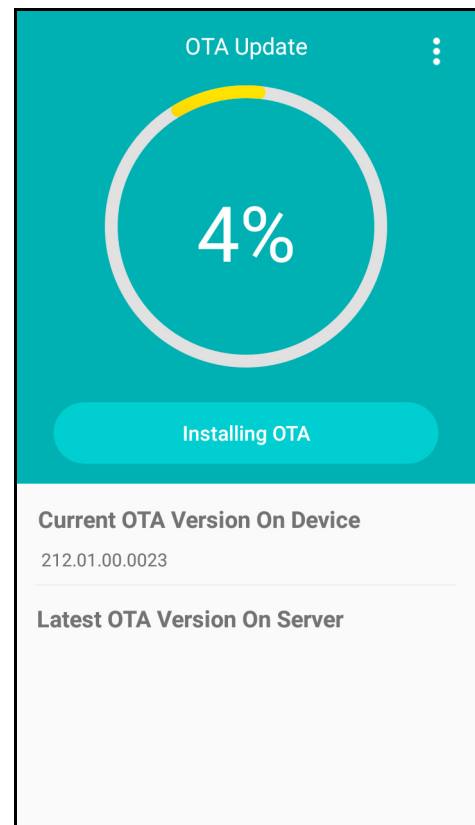
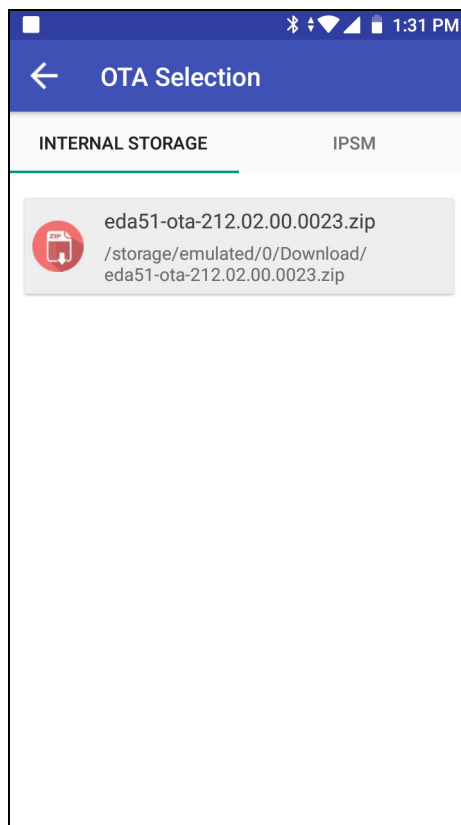

9. Once the installation is complete (100%), select **OK** when prompted to **Reboot** the computer. The computer reboots and finishes the update.

# Reboot (Restart) the Computer

You may need to restart the computer to correct conditions where an application stops responding to the system.

1. Save your files and close any open applications.
2. Press and hold the **Power** button until the options screen appears.
3. Tap **Restart**. The computer restarts.

If the touch panel display is unresponsive:

- Press and hold the **Power** button for approximately 8 seconds until the computer restarts.

## About an Enterprise Data Reset

You can perform an Enterprise data reset if a Reboot did not improve the condition and all other troubleshooting methods have not resolved the issue. This method provides a clean configuration for troubleshooting by erasing all data from the Internal shared storage location on the computer. Data is not erased from the IPSM Card location.





**Caution:** An Enterprise data reset results in data loss, only perform this procedure if all other recovery methods have failed. All personal content is erased including, but not limited to emails, pictures, contacts, Google account information, system settings and app settings.

**Note:** This method of recovery may not be available if your system administrator has set policies to prevent the reset use.

## Before You Begin

- If you recently reset your Google Account password, wait 24 hours before performing a Enterprise data reset.
- Make sure you have your screen lock password, PIN or pattern if you activated one. You will need this to reset the computer.
- If you have a Google Account, back up your data and settings to your Google Account so you can restore them if needed.
- Connect the computer to an external power source or make sure you have a full battery charge.
- Make sure you have an Internet connection.

# Enterprise Data Reset the Computer

1. Swipe up from the bottom of the Home screen to access all apps.
  2. Select **Settings**  > **System** > **Advanced** > **Reset options**.
  3. Tap **Enterprise data reset**.
  4. Tap **Reset Phone**.
  5. If prompted, type your screen lock security pattern, PIN, or password and tap next (  ).
- Tap **Erase Everything**. A message appears informing you an Enterprise data reset is being performed.

## About Full Factory Reset

A Full Factory Reset should only be performed if you have exhausted all other troubleshooting options. This method reverts the computer back to the factory state by erasing all data in **Internal shared storage** and the **IPSM Card** storage locations on the computer.





**Caution:** A Full factory reset results in data loss. Perform this procedure only if all other recovery methods have failed and have no other option. All personal content is erased including, but not limited to emails, pictures, contacts, Google account information, system settings and app settings.

**Note:** This method of recovery may not be available if your system administrator has set policies to prevent the reset use.

## Before You Begin

- If you added a Google Account to the EDA51K computer, make sure you have your Google username and password associated with the computer. If you do not have the username and password, you will not be able to use the computer after the reset. This is a security measure that prevents unauthorized users from using the device if they try a Full factory reset.
- If you did not add a Google Account to the computer, the extra security level is not enabled and you will not need a Google username and password.
- If you recently reset your Google Account password, wait 24 hours before performing a Full factory reset.
- Connect the computer to an external power source or make sure you have a full battery charge.
- Make sure you have an Internet connection.

# Full Factory Reset the Computer

1. Swipe up from the bottom of the Home screen to access all apps.
2. Select **Settings**  > **System** > **Advanced** > **Reset options**.
3. Tap **Erase all data (factory reset)**.
4. Tap **Reset Phone**.
5. If prompted, type your screen lock security pattern, PIN, or password and tap next (  ).
6. EDA51K will restart and automatically clear user data.
7. Tap **Erase Everything**. A message appears informing you an Enterprise data reset is being performed.

## Repairs

Repairs and/or upgrades are not to be performed on this product. These services are to be performed only by an authorized service center (see [Customer Support](#) on page ix).

## Maintenance

Your device provides reliable and efficient operation with a minimum of care. Although specific maintenance is not required, the following sections describe periodic checks to ensure dependable operation.

## Clean the computer

The computer housing, scanner window, camera window and touch screen may be cleaned with a soft cloth dampened with water or a mild detergent-water solution. If a mild detergent solution is used, wipe the computer with a clean cloth dampened only with water to remove any detergent residue.

**Note:** *Reading performance may degrade if the scanner window is not clean. If the window is visibly dirty, or if the scanner is not operating well, clean the window.*

**Caution:** **Do not submerge the computer in water or cleaning solution. Do not use abrasive wipes or cloths on the windows or touch screen. Abrasive wipes may scratch the windows and touch screen. Never use solvents (e.g., acetone) on the housing or window. Solvents may damage the computer finish, the windows or touch screen.**



**Caution:** **Ensure all components are dry prior to mating the computer with charging accessories or other peripheral devices. Mating wet components may cause damage not covered by the warranty.**





## Computer Agency Information

EDA51K mobile computers meet or exceed the requirements of all applicable standards organizations for safe operation. The best way to ensure safe operation is to use the mobile computer according to the agency guidelines on the product regulatory sheet, quick start guide and in this user guide. Read all guidelines before using your computer.

Product documentation is available for download from [www.honeywellaidc.com](http://www.honeywellaidc.com).

Public certificates are available for download from [www.honeywellaidc.com/compliance](http://www.honeywellaidc.com/compliance).

## Label Locations

Labels inside the battery compartment contain information about the computer including, compliance information, model number, serial number, IMEI number (EDA51K-1 models only) and MAC address. Laser safety labeling is located on the back of the computer.

Compliance Label Location and  
Model Dependent Identification Numbers  
(e.g. Serial Number, IMEI, MEID, MAC address)

Laser Safety Label Location

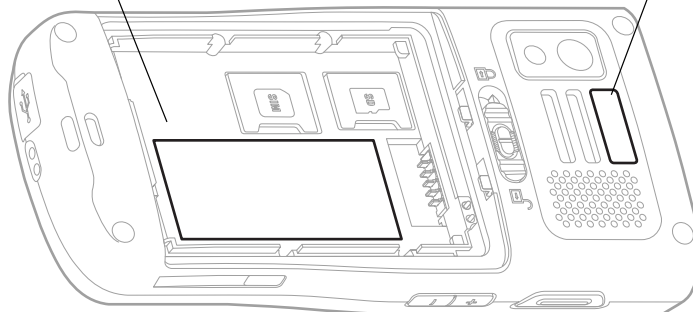

# Physical and Environmental Specifications

1. Go to [www.honeywellaidc.com](http://www.honeywellaidc.com).
2. Type EDA51K in the Search box and then press **Enter**.
3. Select the **Products** tab.
4. Click the red arrow under the EDA51K *computer* description.
5. Select one of the following:
  - **Specifications**  
View System Architecture, WWAN Connectivity, Mechanical, and Environmental specifications.
  - **Documents and/or References**  
Download the Data Sheet, Accessory Guide, Quick Start Guide, User Guide, Regulatory Information, Battery Information and other product documentation.

## Imager Specifications

The EDA51K series offers three Honeywell high-performance imager options:

- N3603 Imager Engine
- N6703 Ultra-Slim Imager Engine

## Bar Code Symbolologies

The computer supports the following bar code symbolologies:

1D Symbolologies		2D Symbolologies		Postal Codes	
	Default		Default		Default
Code 128	Enabled	DataMatrix	Enabled	China Post	Disabled
GS1-128	Enabled	Grid Matrix	Disabled	Korea Post	Disabled
Code 39	Enabled	Aztec Code	Enabled	2D Postal Settings	Disabled
UPC-A	Enabled	Codablock A	Disabled		
UPC-E	Enabled	Codablock F	Disabled		
EAN-8	Enabled	Digimarc	Disabled		
EAN-13	Enabled	Dotcode	Disabled		
Codabar	Enabled	HanXin	Disabled		
Code 11	Disabled	Maxicode	Disabled		
Code 93	Disabled	Micro PDF 417	Disabled		
Composite	Disabled	PDF 417	Enabled		
GSI Databar	Disabled	QR Code	Enabled		

1D Symbologies		2D Symbologies		Postal Codes	
	Default		Default		Default
IATA 2 of 5	Disabled	TLC 39	Disabled		
Interleaved 2 of 5	Enabled	OCR	Disabled		
Matrix 2 of 5	Disabled				
MSI	Disabled				
Standard 2 of 5	Disabled				
Telepen	Disabled				
Trioptic	Disabled				

**Note:** To learn about changing the symbology settings, see [Change the Scanner Settings](#) on page 34.

## N6703 Ultra-Slim Imager Engine Reading Distances

The depth of field measurements were taken using these parameters:

- Distances are measured from the front of the engine to the bar code
- Clear, High quality bar codes

### Typical Specs

Focus		Standard Range (SR)	
Symbology		Near Distance	Far Distance
5 mils Code 39	cm	7.0	30.10
	in.	2.76	11.85
10 mils Code 39	cm	2.9	51.7
	in.	1.14	20.30
20 mils Code 39	cm	3.5	80.0
	in.	1.38	31.50
13 mils 100% UPC-A	cm	3.4	57.3
	in.	1.34	22.50
15 mils Code 128	cm	3.4	65.0
	in.	1.34	25.60
10 mils Data Matrix	cm	7.2	29.7
	in.	2.84	11.7
6.7 mils PDF 417	cm	8.4	24.4
	in.	3.3	9.6
15 mils QR	cm	3.3	39.0
	in.	1.3	15.35

## N6703 Ultra-Slim Imager Engine Field of View/Resolution

Focus	Standard Range (SR)
Horizontal Field Angle (degrees)	48.3 ±1.5°
Vertical Field Angle (degrees)	31.4 ±1.5°

**Note:** *DPI can be calculated based on the following formula:  
 Horizontal DPI = 1280 pixels/width of horizontal field of view (inches)  
 Vertical DPI = 800 pixels/width of vertical field of view (inches)*

## N3603 Imager Engine Reading Distances

The depth of field measurements were taken using these parameters:

- Distances are measured from the top of the engine to the bar code
- Clear, High quality bar codes

### Typical Specs

Focus		Standard Range (SR)	
Symbology		Near Distance	Far Distance
5 mils Code 39	cm	7.5	18.9
	in.	2.95	7.44
10 mils Code 39	cm	3.1	45.5
	in.	1.22	17.91
20 mils Code 39	cm	4.9	74.0
	in.	1.93	29.13
13 mils 100% UPC-A	cm	4.1	54.1
	in.	1.61	21.30
15 mils Code 128	cm	4.6	63.0
	in.	1.81	24.80
10 mils Data Matrix	cm	5.3	16.5
	in.	2.09	6.50
6.7 mils PDF 417	cm	6.3	24.4
	in.	2.48	7.87
15 mils QR	cm	3.0	29.7
	in.	1.18	11.69

# N3603 Imager Engine Field of View/Resolution

Focus	Standard Range (SR)
Horizontal Field Angle (degrees)	49 ±1.5°
Vertical Field Angle (degrees)	32 ±1.5°

**Note:** *DPI can be calculated based on the following formula:  
Horizontal DPI = 1280 pixels/width of horizontal field of view (inches)  
Vertical DPI = 640 pixels/width of vertical field of view (inches)*





Honeywell  
9680 Old Bailes Road  
Fort Mill, SC 29707

[www.honeywellaidc.com](http://www.honeywellaidc.com)