

Status: 07/2021

**cab**  
*we identify more*



Products need labeling  
**Labeling heads**

**IXOR**  
Made in Germany

## Smallest servo-driven labeling head in its performance class

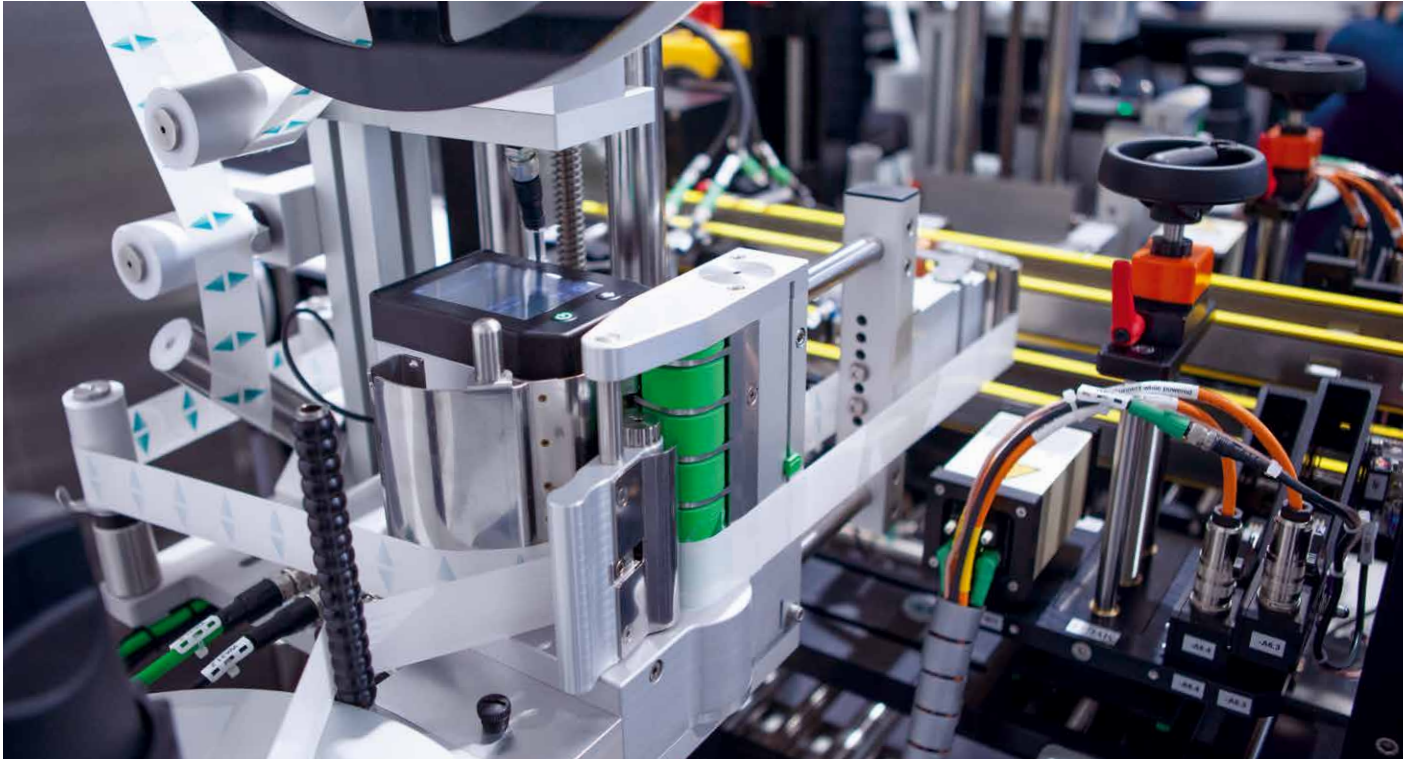

### A future-proof investment

In the matter of mechanics, the IXOR can be ideally integrated in fully automatic labeling machines with the help of a modular construction kit. It can also be assembled to the conveyor belt of a production line by means of accessorial stands. Pre-printed labels are applied on products or packaging fast and precisely.

The device has the control unit integrated, a separate control cabinet is not required. The base unit can be selected from four structural widths in right-hand and left-hand designs. Unwinders pick up label rolls with 410 mm maximum outside diameter.

Zero downtime is possible through a redundant system.

The labeling head is a key component for smart production. The LAN and WLAN interfaces enable the device to be connected to the superior control units of machines.

MQTT, Modbus and OPC UA ensure cross-platform and future-proof communication. Protocols are kept simple and lean, machine and plant data can be submitted event-driven. If data values change, updates are possible in real time.

Remote IXOR operation with a smartphone, a tablet or a PC is possible at any time. The intuitive web interface allows backup, restore and updates.



Scopes of delivery, design and technical specifications correspond to the date of the printing. Subject to change. The data provided in the catalog do not represent any warranty or guarantee.



Information is also available on the Internet:  
[www.cab.de/en/ixor](http://www.cab.de/en/ixor)



## Examples of construction

**Construction L - left-hand**  
**Assembly V - vertical**



Pictured:

- 1.1 Labeling head 124 L
- 2.1 Unwinder D310 V 124 L  
Outside diameter D: 310 mm

**Construction R - right-hand**  
**Assembly V - vertical**



Pictured:

- 1.1 Labeling head 124 R
- 2.2 Unwinder D410 V 124 R  
Outside diameter D: 410 mm

**Construction R - right-hand**  
**Assembly V - vertical**



Pictured:

- 1.1 Labeling head 124 R
- 2.1 Unwinder D410 V 124 R motor-driven  
Outside diameter D: 410 mm

**Construction L - left-hand**  
**Assembly H - horizontal**



Pictured:

- 1.2 Labeling head 186 L
- 2.2 Unwinder D410 H 186 L  
Outside diameter D: 410 mm



For more examples of construction  
see delivery program starting on page 19.

# Operation panel



## Home screen

### 1 Status bar

Speed, label winding, current label roll diameter, label length, WLAN signal, status of start and stop signal

### 2 Operational and warning messages

in alternation with the cab logo

### 3 Counter and diagnostics indication

Application-specific configuration

### 4 Quick menu for comfortable editing of values

Quick adjustment with a slider, precise adjustment with the help of a button

 **Speed**

**Press briefly**  
Labeling speed adjustment

**Press for 3 or more sec.**  
Masterencoder test

 **Start delay**

**Press briefly**  
Change the label position on the product

**Press for 3 or more sec.**  
Start sensor compensation wizard

 **Stop delay**

**Press briefly**  
Adjustment of label stop on the peel-off plate

**Press for 3 or more sec.**  
Label sensor  
AutoTeach feature

 **Menu selection**

**Press briefly**  
Jump to menu via icons

**Press for 3 or more sec.**  
Password login

 **Speed**

40.0 m/min

1.0 100.0



 **Start delay**

330.0 mm

11.6 1000.0



 **Stop delay**

40.6 mm

10.0 500.0



**Menu**

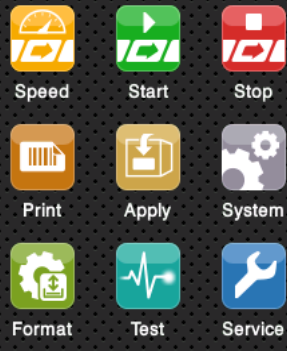

Speed Start Stop  
Print Apply System  
Format Test Service

# Software features

## Menu icons one by one



### Label speed

including synchronized product speed



### System settings

Display, language  
Metric / inch units  
Pre-warning to end of label web



### Label position on the product

including multi-labeling;  
start condition



### Application-specific configuration

a maximum of 100 formats;  
backup and restore with the help of a PC



### Label stop on the peel-off plate

including detection of labels missing on the liner tape;  
stopp condition



### Simulation and testing

Display and setting of inputs and outputs  
for service purposes



### Print settings

for the control of optional printers;  
printing while labels are in motion or not in motion



### Service tools

Maintenance wizard  
Lot counter  
Video tutorials



### Transfer settings

for the control of optional label transfer units  
such as applicators, air-jet box, etc.

## Sub menu and service features



### Sub menu

with more than 150 features

I/O-Test	
Inputs	Outputs
<input type="checkbox"/> FEED Manual label feed	<input type="checkbox"/> BTN_FEED Button FEED press
<input checked="" type="checkbox"/> START Start labeling	<input type="checkbox"/> FEEDING Label feeding
<input type="checkbox"/> LOCK START is locked	<input type="checkbox"/> PRT Start print
<input type="checkbox"/> STOP Stop label feeding	<input checked="" type="checkbox"/> READY Ready to start
<input type="checkbox"/> DIM_IN Diminish. label reel	<input type="checkbox"/> DIM Diminishing label re
<input type="checkbox"/> END_IN End of label reel	<input type="checkbox"/> END End of label reel
<input checked="" type="checkbox"/> ON ON/OFF by input	<input type="checkbox"/> NO_LABEL Missing label
<input checked="" type="checkbox"/> RESET Reset error	<input type="checkbox"/> ERROR Stopped by error

### I/O test

Status display of all inputs and outputs;  
ideal with initial operation, especially  
when the labeling head integrates  
in external control units

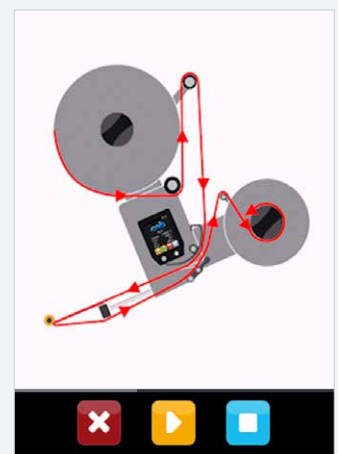

### Video tutorials

Watch feed path schemes on the  
display. Scan QR code with a mobile  
device to see more explanatory clips.

## Details - standard labeling head

The subsequent illustration shows a very common IXOR version.

This configuration is characterized by an economic and compact construction.

The unwinder and the rewinder are mounted directly on the base unit and operate without a separate drive.

In contrast, the illustration on the right shows an IXOR with a motor-driven unwinder and a motor-driven rewinder, enabling to process large label rolls.

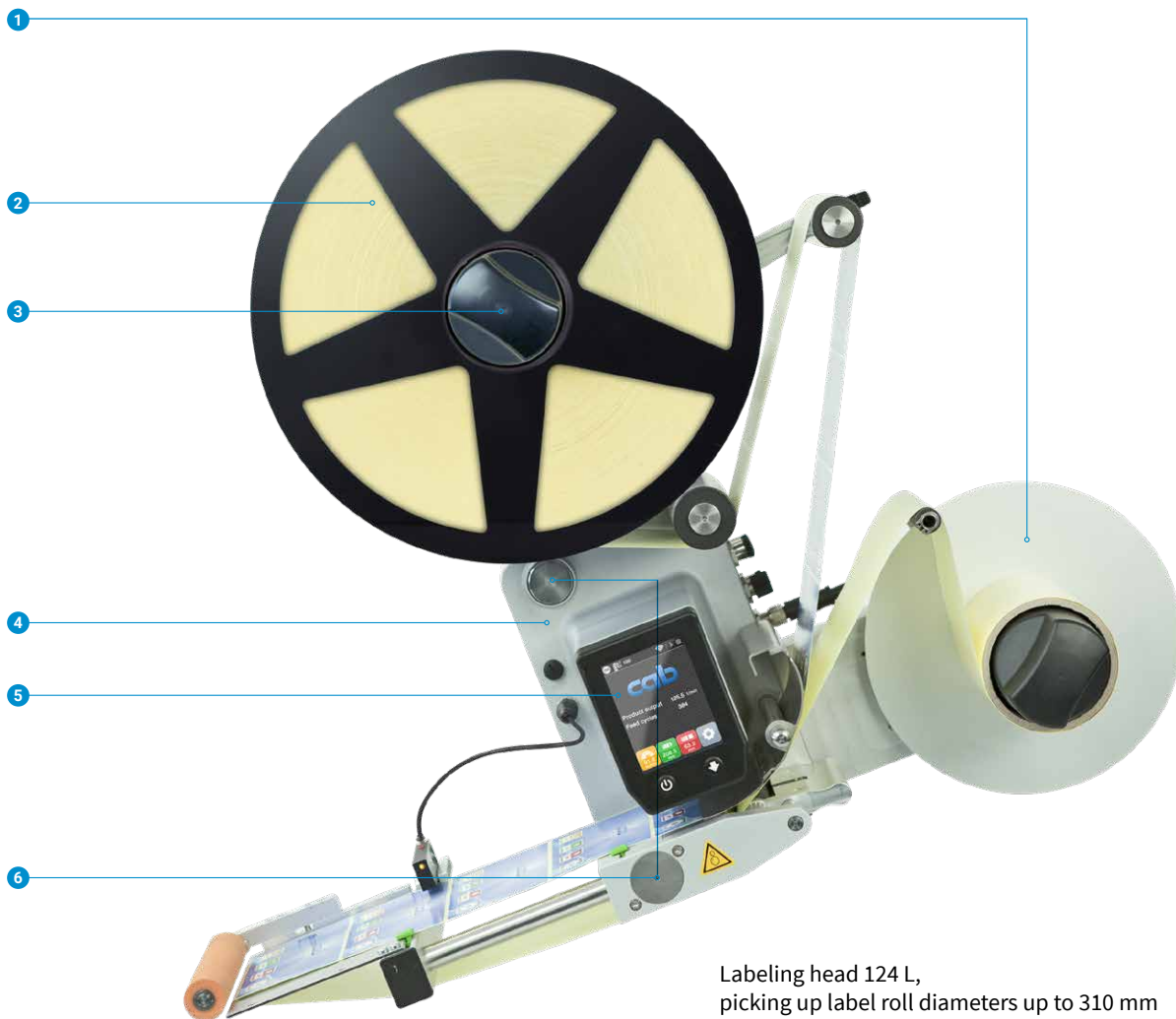

Labeling head 124 L,  
picking up label roll diameters up to 310 mm

### 1 Rewinder

When the labels have been peeled off, the liner tape is rewound. The swing lever and an integrated coupling enable the liner tape to be constantly tensed after passing the drive roller.

### 2 Unwinder

picking up label rolls with 310 mm (optionally 410 mm) maximum outside diameter. The swing lever and an integrated brake mechanism enable constant tension of the label web.

### 3 (Label roll) core retainer

By turning the handle, the core of the label roll is tightened and released again.

### 4 Base unit

made of cast aluminum. Basis to assemble all the units. The chassis possesses protection class IP66, NEMA 250 type 12. Further included is the drive unit consisting of a highly dynamic and high-torque servo motor.

### 5 Operation panel

Colored 3.5" LCD touch display. In case of overhead assembly, the display can be rotated by 180°.

### 6 Pick-up points

on bars with 30 mm diameter. By moving the system, the position of the label on the product can be adjusted transverse to its transport direction.

## Details - labeling head 124 L with motor-driven winders

Labeling head 124 L,  
picking up label roll diameters up to 410 mm

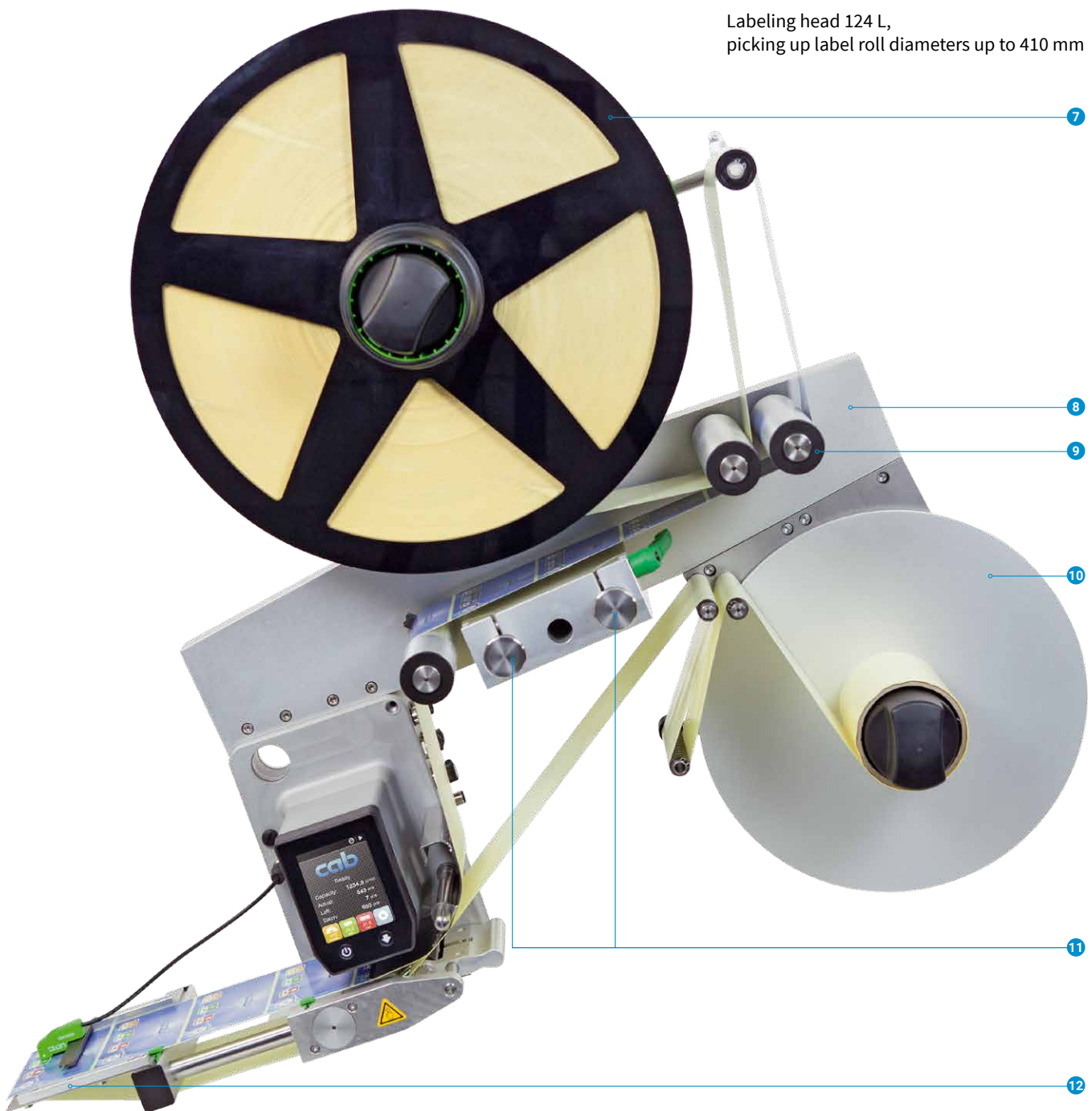

- 7 Motor-driven unwinder**  
picking up label rolls with 410 mm (optionally 510 mm) maximum outside diameter. An integrated, brushless torque motor rotates the label roll and unwinds the label web according to the swing lever position.
- 8 Fixing bar**  
to pick up all the units: base unit and motor-driven winders
- 9 Deflection rollers**  
to guide the label web from the motor-driven unwinder to the base unit. Diameter 38 mm as pictured above

- 10 Motor-driven rewinder**  
When the labels have been peeled off, the liner tape is rewound. The swing lever and an integrated, brushless torque motor enable the liner tape to be constantly tensed after passing the drive roller.
- 11 Pick-up points**  
see position **6**
- 12 Peel-off plate**  
to be application-specifically configured with the help of a comprehensive construction kit.

# Base unit

The base unit can be considered the heart of every labeling head. Included are the drive roller for label web transport, a brushless servo motor and the control unit containing the operation panel.



Interfaces:

- 1 END/DIM Inputs**  
End of label web  
Pre-warning to end of label web

**2 LAN**

- 3 START Input**  
Labeling

**4 Digital I/O interface**

**Analog inputs**

- Speed
- Start delay
- Stop delay

**Digital inputs**

- Labeling head ON
- Pre-dispense
- Start labeling
- Start labeling locked
- Error reset
- User-defined

**Outputs**

- Labeling head ready
- Pre-dispense
- Stop label feed
- Label feed running
- Label missing on liner tape
- End of label web
- Pre-warning to end of label web
- Error
- User-defined

- 5 SYNC Input**  
Synchronized label and product speed

- 6 APPLY USB Inputs**  
Transfer unit in initial position  
Transfer unit in operating position  
Printer busy

- Outputs**  
Transfer unit  
Label blow-off  
Start printer

**7 POWER**

- 8 PRINT Input**  
Printer busy

- Outputs**  
Start printer  
Start transfer unit

**9 WLAN**

- 10 STOP Input**  
Label sensor stop signal

- Output**  
Label sensor Teach signal





# Technical data - labeling head

Labeling head	Structural width	124 mm (4.9")	186 mm (7.3")	248 mm (9.7")	310 mm (12.2")	
<b>Performance</b>						
Web speed	up to m/min	25, 50, 100, 200 - depending from device model				
	up to ipm	1,000, 2,000, 4,000, 8,000 - depending from device model				
<b>Material</b>						
Labels on roll		Paper, plastics PET, PE, PP, PVC				
Thickness	mm	0.055 - 1				
Weight	g/m <sup>2</sup>	60 - 700				
Width	Labels <sup>1)</sup>	up to mm	120	182	244	306
	Liner tape	up to mm	124	186	248	310
Label length	mm	5 - 6,000				
Media roll	Outside diameter	310/410 mm (12"/16")			410 mm (16")	
	Core diameter	76 mm (3")				
	Winding	outside or inside				
Weight	up to kg	15				
<b>Labeling head sizes and weights</b>						
Height	with media roll 310 mm min. mm	600 x 600			-	
x Width	with media roll 410 mm min. mm	700 x 680			825 x 925	
Depth	mm	266	328	390	452	
Weight	min. kg	14	14.5	15	32	
<b>Device data</b>						
Drive		AC servo motor				
Operation panel		QVGA-resoluted LCD color display				
Masterencoder (option)		24 V HTL, track A + B				
Orientation of assembly		vertical / horizontal				
<b>Label sensor</b>						
Method		Transmitted light, inductive, capacitive <sup>2)</sup> , ultrasonic <sup>2)</sup>				
Function		Detection of label margins and end of materials				
<b>Interfaces</b>						
Digital I/O interface		17 pin, 24 V PNP to communicate signals with a superior control unit (galvanically isolated)				
Analog		Inputs (0-10 V / 0-24 V) for speed, <b>START</b> , <b>STOP</b> parameters in conjunction with PLC supplied by the customer or potentiometer (galvanically isolated)				
LAN		MQTT, Modbus, OPC UA, Ethernet/IP <sup>2)</sup>				
WLAN		WLAN 802.11 b/g/n, 150 MBit/s, 2.4 GHz				
Periphery ( <b>APPLY</b> )		12 pin, to connect USB warning light and applicator (24 V PNP, galvanically isolated)				
End of web sensor		5 pin, 24 V PNP or end of web sensor by cab				
Start and stop sensor		5 pin each, 24 V PNP (galvanically isolated)				
Synchronized product speed		5 pin, 24 V PNP external synchronization signal or by masterencoder (galvanically isolated), masterencoder is an option				
Serial (option)		RS232/RS485				
<b>Operating data</b>						
Mains   Protection class		primarily TN and TT grids   Protection class I				
Power supply   Power consumption		100 - 240 VAC, 50 - 60 Hz   up to 4 A				
External fusing		120 V: at least 6 A slow, up to 20 A / 230 V: at least 3 A slow, up to 16 A				
Leakage current		EN 60950: 260 V / 60 Hz: 1.0 mA				
Type of protection		IEC 60529: IP 66, UL 50 type 12, NEMA 250 type 12				
Temperature / humidity	Operation	0 - 40 °C / 10 - 85 %, not condensing				
	Stock	0 - 60 °C / 20 - 80 %, not condensing				
	Transport	-25 - 60 °C / 20 - 80 %, not condensing				
Approvals		CE, FCC, IC, ICES-3, CB, cULus				
<b>Operation panel</b>						
LED buttons		ON, FEED				
LCD graphics display	Width x Height mm	54 x 70				
Settings		Language settings, device settings, interfaces, memory for 100 product formats				
On display		Operational and warning messages				
<b>Monitoring / test routines</b>						
Label web		Pre-warning to end of label web, end of label web, label web broken				
Drive		Torque, temperature, power supplies, currents				
Electrical outputs		Overload protection, short circuit, reverse polarity				
System		Diagnostics when device is switched on, I/O test menu integrated				

<sup>1)</sup>The label size is further defined by the type of applicator. Limitations may apply to small labels, thin materials or strong adhesive. Such applications need to be tested.

<sup>2)</sup> on request

## Motor-driven winders

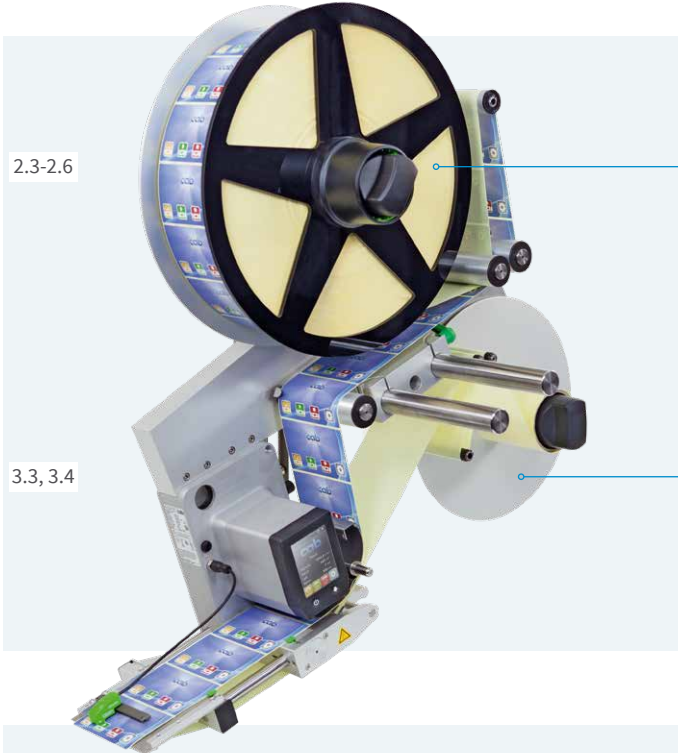

Use is in combination with the base unit.  
They are operated via the operation panel of the labeling head.

- 1 **Motor-driven unwinder**  
picking up the label roll and providing the label web;  
fitting with large label roll diameters up to 410 / 510 mm  
and high labeling performances
- 2 **Motor-driven rewinder**  
picking up the liner tape;  
available in diameters 310 and 410 mm;  
ideally operated in conjunction with a motor-driven unwinder

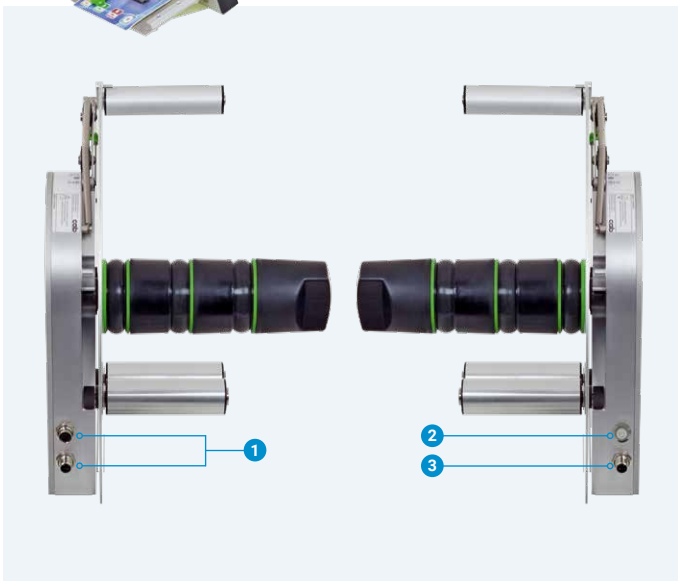

Interfaces:

- 1 **POWER**  
Power supply IN/OUT
- cab BUS**  
Data interface to base unit
- 2 **ON/OFF switch**
- 2 **Digital I/O interface** (option)
  - Inputs**
  - Winder ON
  - Error reset
  - User-defined
  - Outputs**
  - Winder ready
  - End of label web
  - Pre-warning to end of label web
  - Error
  - User-defined

## Technical data - motor-driven winders

Winder motor-driven		Structural width	124 mm (4.9")	186 mm (7.3")	248 mm (9.7")	310 mm (12.2")
<b>Performance</b>						
Web speed		up to m/min	125			
		up to ipm	5,000			
<b>Material</b>						
Labels on roll			Paper, plastics PET, PE, PP, PVC			
Thickness		mm	0.055 - 1			
Weight		g/m <sup>2</sup>	60 - 700			
Width	Labels	up to mm	120	182	244	306
	Liner tape	up to mm	124	186	248	310
Label length		mm	5 - 6,000			
Media roll	Outside diameter		410 / 510 mm (16"/20")			
	Core diameter		76 mm (3")			
	Winding		outside or inside			
Weight	Unwinder	up to kg	30			
	Rewinder	up to kg	15			
<b>Winder sizes and weights</b>						
Height	with media roll 410 mm min. mm		430 x 490			
	x Width with media roll 510 mm min. mm		530 x 590			
Depth		mm	266	328	390	452
Weight		min. kg	7			
<b>Device data</b>						
Drive			brushless torque motor			
Orientation of assembly			vertical / horizontal			
<b>Interface</b>						
Digital I/O interface (option)			12 pin, 24 V PNP to communicate signals with a superior control unit (galvanically isolated)			
<b>Operating data</b>						
Mains   Protection class			primarily TN and TT grids   Protection class I			
Power supply   Power consumption			100 - 240 V~, 50 - 60 Hz   up to 2 A			
POWER IN   POWER OUT			up to 12 A   up to 10 A			
External fusing			100 V: at least 3 A slow, up to 20 A / 230 V: at least 1.5 A slow, up to 16 A			
Leakage current			EN 60950: 260 V / 60 Hz: 0.5 mA			
Type of protection			IEC 60529: IP 66, UL 50 type 12, NEMA 250 type 12			
Temperature / humidity	Operation		0 - 40 °C / 10 - 85 %, not condensing			
	Stock		0 - 60 °C / 20 - 80 %, not condensing			
	Transport		-25 - 60 °C / 20 - 80 %, not condensing			
Approvals			CE, FCC, IC, ICES-3, CB, cULus			
<b>Monitoring / test routines</b>						
Label web			Pre-warning to end of label web, end of label web, label web broken			
Drive			Torque, temperature, power supplies, currents			
Electrical outputs			Overload protection, short circuit, reverse polarity			
System			Diagnostics when device is switched on			

## Peel-off plates

4.1, 4.2



### Peel-off plate standard

provided in lengths of 100 mm or 160 mm



pictured with a label sensor CEON and a wipe-down roller

4.4, 4.5



### Peel-off plate adjustable 0° to +75°

to be continuously adjusted at angles from 0° to +75° to the corresponding application field.



pictured with a label sensor CEON and a wipe-down roller

4.6, 4.7

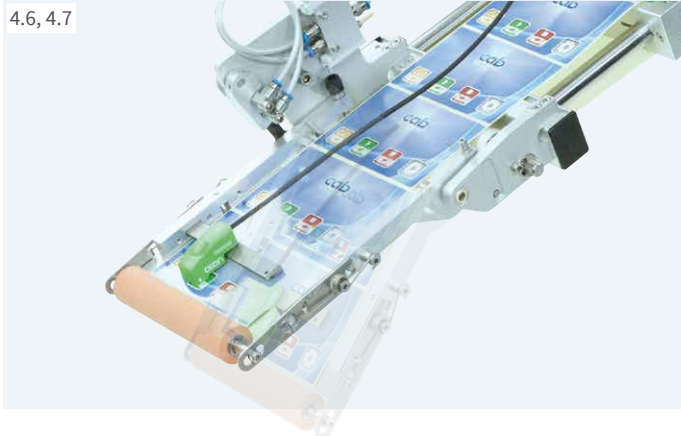

### Peel-off plate pivoted 0° to -30°

swinging downwards by up to -30°. The pneumatic drive is controlled via the base unit (pictured are 124 mm). Structural widths of at least 186 mm provide drives on both sides. Uneven products can be labeled and labels be dispensed into pockets.



pictured with a label sensor CEON and a wipe-down roller

4.9



### Peel-off plate 75° with a wipe-down roller

as a size-optimized unit with a fixed 75° label tape deflection angle. A spring-mounted wipe-down roller to be adjusted in rest position is included next to a retainer to fix the label sensor CEON.



pictured with a label sensor CEON

## Accessories

5.1



### Label sensor CEON

to detect and exactly position all conventional (even particularly thin, transparent or metallized) label materials at any mesh width:

- easy to assemble on the peel-off plate
- precise detection even at very high dispensing speeds up to 24,000 ipm
- high repeat accuracy
- comfortable AutoTeach sensor balance directly on the labeling head
- Operating voltage 15 to 30 VDC
- Push-pull amplifier output: PNP, NPN, 40mA, short-circuit proof

11.1



### I/O box

to extend the programmable inputs and outputs provided with the labeling head. The signals are mainly used for customer-specific label application system control:

- 1 **Connection to labeling head**  
M12, 12 pin
- 2 **Connection to further participant**  
M12, 12 pin
- 3 **Digital inputs/outputs, analog inputs**  
M8, 3 pin

A total of 12 inputs and outputs are available per box.

16.1



### External operation panel 4.3"

providing the same functionality as on the labeling head; landscape or portrait mode display









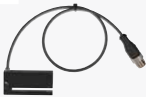

Users are free to choose whether to operate the labeling head on the external panel or on the one integrated in the device.









- 1 **LED:** Power ON
- 2 **USB slot** to connect a memory stick in order to transfer configuration data or the firmware











A maximum of three participants can be connected to the base unit: for example 2 x I/O box, 1 x external operation panel

# Accessories

Label margin detection	
5.2	 <p><b>Retainer bar</b> to assemble the label sensor CEON on the peel-off plates</p>
5.3	 <p><b>Forked light barrier</b> to detect translucent labels with transparent or semi-transparent liner tapes; optical operation principle (transmitted light)</p>
5.4	 <p><b>Retainer</b> to assemble the forked light barrier on the assembly rods 7.1</p>
Software key	
6.1	 <p><b>Speed key</b> to define the maximum labeling speed for the base units 1.1 to 1.4</p>
Assembly rod	
7.1	 <p><b>Rod, diameter 16 mm</b> to assemble the peel-off plates 4.1 to 4.6 on the base units 1.1 to 1.4</p> <p>Depending from the orientation of assembly, users can choose between different lengths. Distance peel-off plate to base unit 0 to 600 mm</p>
Product detection	
8.1	 <p><b>Product sensor</b> to trigger the labeling process as soon as the product has been detected. The maximum scanning range standard is 200 mm, with transparent products it is 80 mm.</p>
8.2	 <p><b>Product sensor cable</b> M12-M8, 4 pin, a-coded Length 2.5 m</p>
Masterencoder	
9.1	 <p><b>Rotary encoder, incremental, diameter 50 mm</b> with cable 2.5 m and plug M12, 5 pin, a-coded A and B tracked to automatically synchronize the labeling speed</p>
9.2	 <p><b>Extender cable for rotary encoder</b> M12, 5 pin, a-coded Lengths 2.5 m, 5 m, 10 m</p>
9.3	 <p><b>Friction wheel for rotary encoder</b> to drive the master encoder by means of friction; circumference 200 mm</p>
9.4	 <p><b>Retainer for rotary encoder</b> The friction wheel is pressed onto the conveyor belt in a spring-mounted manner.</p>

Power supply cable	
10.1	 <p><b>Power supply cable without a Schuko plug</b> Lengths 2.5 m, 5 m, 10 m</p>
10.2	 <p><b>Power supply cable with Schuko plug</b> Length 2.5 m</p>
Signal cable	
10.3	 <p><b>I/O interface cable</b> Exchange of signals between the labeling head and a superior control unit; for signal description see page 8; lengths 2.5 m, 5 m, 10 m</p> <p>With circular connectors: 1) Cable plug M12, 17 pin, male 2) Cable jack M12, 17 pin, female</p>
10.4, 10.5	 <p><b>Signal cable</b> Exchange of signals between the labeling head and label transfer units; for signal description see page 8; lengths 1 m, 2.5 m</p> <p>With circular connectors: 1) Cable plug M12, 12 pin, male 2) Cable jack M12, 12 pin, female</p>
LAN cable	
10.6	 <p><b>Ethernet cable</b> M12, 4 pin, d-coded to RJ45 Lengths 2.5 m, 5 m, 10 m</p>
USB cable	
10.7	 <p><b>Cable to connect an external operation panel</b> M12, 12 pin to USB-B Length 5 m</p>
10.8	 <p><b>USB adapter to connect a memory stick</b> to IXOR <b>APPLY</b> for backup and restore Cable M12, 12 pin to USB-A Length 0.2 m</p>
Power cable	
10.9	 <p><b>Power cable to connect winders or winders with the base unit</b> Lengths 0.3 m, 0.8 m, 2.5 m</p>
Counterholder	
12.1	 <p><b>Counterholder 310 mm</b> to be used with a diameter 310 mm unwinder in vertically oriented labeling head assembly. It prevents the label web from accidentally sliding off the media roll.</p> <p><b>Counterholder 410 mm</b> to be used with a diameter 410 mm unwinder/ motor-driven unwinder in vertically oriented labeling head assembly. It prevents the label web from accidentally sliding off the media roll.</p> <p><b>Counterholder 510 mm</b> to be used with a diameter 510 mm unwinder/ motor-driven unwinder in vertically oriented labeling head assembly. It prevents the label web from accidentally sliding off the media roll.</p>

# Accessories

<b>Cover plate</b>	
13.1 	<p><b>Plate</b> to cover the mechanical port on which the rewinder connects to the base unit. It is needed if no mechanical rewinder is assembled directly on the base unit.</p>
<b>Circular connector</b>	
14.1 	<p><b>Cable plug M12, 5 pin, a-coded, male</b> It allows to configure connecting cables yourself for the following interfaces: <b>START</b> <b>END/DIM</b> <b>PRINT</b> <b>STOP</b> For signal description see page 8</p>
	<p><b>Cable plug M12, 12 pin, male</b> It allows to configure connecting cables yourself for the following interface: <b>APPLY</b> on the side next to the labeling head For signal description see page 8</p>
14.2 	<p><b>Cable jack M12, 5 pin, a-coded, female</b> It allows to configure connecting cables yourself for the following interface: <b>SYNC</b> For signal description see page 8</p>
	<p><b>Cable jack M12, 12 pin, female</b> It allows to configure connecting cables yourself for the following interface: <b>APPLY</b> on the side next to the label transfer unit For signal description see page 8</p>
<b>Signal</b>	
15.1 	<p><b>Warning light</b> In addition to the display, it indicates the status of the device. <b>Red</b> Group error, e. g. end of label web, label web broken <b>Yellow</b> Pre-warning to end of label web <b>Green</b> Device ready It is assembled with the help of the stand included in delivery; length of cable is 2.5 m With 17 pin M12 circular connector to connect to the <b>digital I/O interface</b></p>
<b>Wipe-down system</b>	
17.1 	<p><b>Wipe-down roller, wipe-down brush</b> to tamp labels on products in motion</p>
<b>Assembly aid</b>	
18.1, 18.2 	<p><b>Fixing bars</b> to assemble motor-driven winders and the base unit</p>
<b>Deflection roller</b>	
19.1 	<b>Deflection roller</b> D30 AL, paper guide integrated
	<b>Deflection roller</b> D38 AL, paper guide integrated
	<b>Deflection roller</b> D60 AL, paper guide integrated
<b>Spacer</b>	
20.1 	<p><b>Spacer</b> for motor-driven unwinders D510, rewinders D410</p>

## Accessories

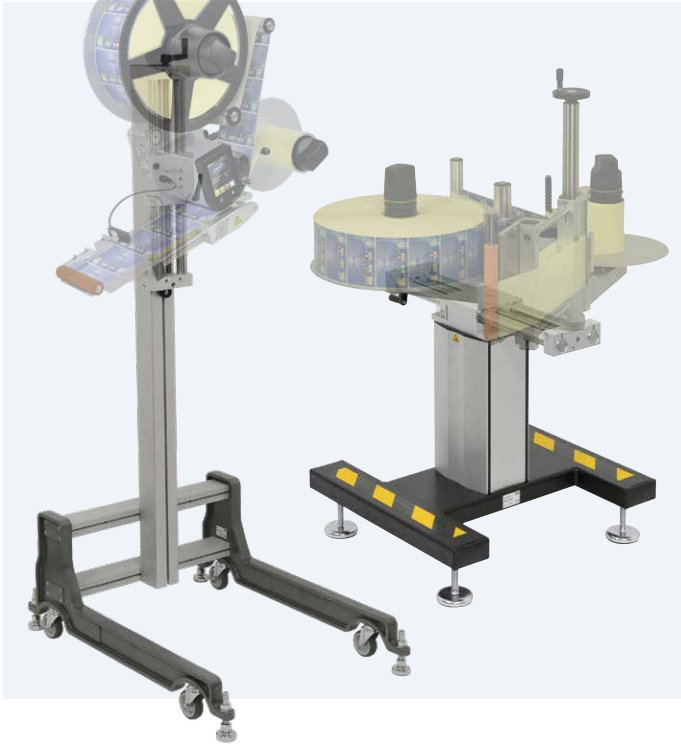

### Assembly aids

to assemble the labeling head customer-specifically in production lines or integrate it in labeling machines. At this, a construction kit is provided, including

- **device retainers,**
- **column stands,**
- **floor stands.**

21.1

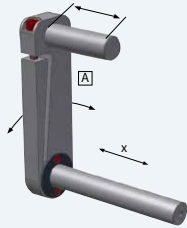

### **A** Pivoted device retainer

to adjust the inclination of the labeling head. For example, the peel-off angle "label to product" can be set. Labeling head assembly is possible in three methods.

#### **Method 1: Device fixed**

**to vertically or horizontally assemble the labeling head**

The labeling head cannot be adjusted in x-axis direction.

21.2

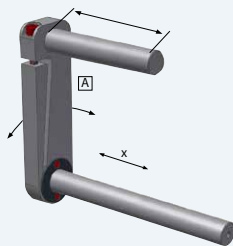

#### **Method 2: Device moveable**

**to vertically assemble the labeling head**

The labeling head can be adjusted in x-axis direction by 200 mm transverse the direction labels are peeled off. In case of wipe-down labeling, the label position on the product may be varied transverse the transport direction of the product.

If no **A** pivoted device retainer is assembled, the adjustable track increases by 26.5 mm.

21.3

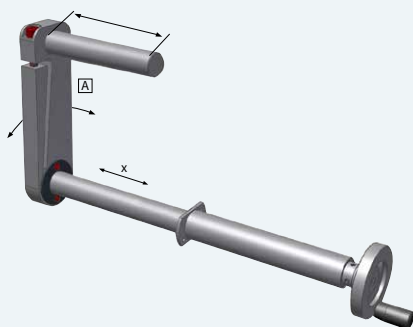

#### **Method 3: Device precisely adjustable**

**to vertically or horizontally assemble the labeling head**

The labeling head can be precisely adjusted by 150 mm in x-axis direction transverse the direction labels are peeled off with the help of a hand crank. In case of wipe-down labeling, the label position on the product may be varied transverse the transport direction of the product.



## Accessories

22.1



### Column stand, one axis

to assemble the labeling head to a conveyor belt;  
position is set with the help of a hand crank

Technical data		Column stand
Column length	mm	400 - 800
Adjustable track	mm	column length in mm - 205 mm
Column diameter	mm	30

22.2



### Column stand, two axes

to assemble the labeling head to a conveyor belt;  
position is set with the help of a hand crank

Technical data		Column stand
Column length	mm	400 - 800
Adjustable track	mm	column length in mm - 205 mm
Column diameter	mm	30

22.3



### Floor stand 1632 vertical

primarily for labeling from the top on a product. It is moveable.  
On site, locking and setting is possible with the help of leveling feet.  
Preferred use is with applications in various production lines

Technical data		Floor stand 1632
Leveling feet, adjustability	mm	± 15
Load	up to kg	50
Load at protrusion 300 mm	up to kg	25
Distance from lower label margin to the floor	mm	880 - 1,200
Weight	approx. kg	40

22.4



### Floor stand 1231 horizontal

primarily for labeling from the side on a product. It is adjustable  
in height and can be locked and set with the help of leveling feet  
on site. Preferred use is with applications in various production lines

Technical data		Floor stand 1231
Leveling feet, adjustability	mm	± 15
Load	up to kg	50
Load at protrusion 200 mm	up to kg	20
Distance from lower label margin to the floor	mm	664 - 904
Weight	approx. kg	40

# Overview of accessories

■ typical □ on request

Pos.	Labeling head	Structural width up to m/min	124 mm					186 mm					248 mm					310 mm		
			30	40	50	100	200	30	40	50	80	150	30	40	50	80	100	30	40	50
<b>Winder</b>																				
2.1	Unwinder, diameter 310 mm		■	■	■	□	-	■	■	■	□	-	■	■	□	-	-	-	-	-
2.2	Unwinder, diameter 410 mm		■	■	■	-	-	■	■	□	-	-	■	□	-	-	-	-	-	-
2.3, 2.4	Unwinder motor-driven, diameters 410, 510 mm		□	□	□	□	-	□	□	□	□	-	□	□	□	□	-	□	□	□
2.5, 2.6	Unwinder motor-driven with a double pendulum, diameters 410, 510 mm		□	□	□	□	□	□	□	□	□	□	□	□	□	□	□	□	□	□
3.1	Rewinder, diameter 210 mm		■	■	■	□	-	■	■	□	-	-	■	□	-	-	-	-	-	-
3.2	Rewinder, diameter 290 mm		■	■	□	-	-	■	□	-	-	-	□	-	-	-	-	-	-	-
3.3, 3.4	Rewinder motor-driven, diameters 310, 410 mm		□	□	□	□	□	□	□	□	□	□	□	□	□	□	□	□	□	□
4.1-4.10	Peel-off plates, rollers, installation profiles		■	■	■	■	■	■	■	■	■	■	■	■	■	■	■	□	□	□
<b>Label margin detection</b>																				
5.1, 5.2	Label sensor CEON, retainer bar		■	■	■	■	■	■	■	■	■	■	■	■	■	■	■	■	■	■
5.3, 5.4	Forked light barrier, retainer		■	■	■	■	□	■	■	■	■	□	■	■	■	■	■	■	■	■
<b>Software key</b>																				
6.1	Speed key		■	■	■	■	■	■	■	■	■	■	■	■	■	■	■	■	■	■
<b>Assembly rod</b>																				
7.1	Rod to assemble the peel-off plate		■	■	■	■	■	■	■	■	■	■	■	■	■	■	■	■	■	■
<b>Product detection</b>																				
8.1, 8.2	Product sensor, cable		■	■	■	■	■	■	■	■	■	■	■	■	■	■	■	■	■	■
<b>Masterencoder</b>																				
9.1-9.4	Rotary encoder, cable, friction wheel, retainer		■	■	■	■	■	■	■	■	■	■	■	■	■	■	■	■	■	■
<b>Cable</b>																				
10.1-10.9	Power supply cable, signal cable, LAN cable, USB cable, power cable		■	■	■	■	■	■	■	■	■	■	■	■	■	■	■	■	■	■
<b>Interface</b>																				
11.1	I/O box		■	■	■	■	■	■	■	■	■	■	■	■	■	■	■	■	■	■
<b>Circular connector</b>																				
14.1, 14.2	Cable plug M12, cable jack M12		■	■	■	■	■	■	■	■	■	■	■	■	■	■	■	■	■	■
<b>Signal</b>																				
15.1	Warning light		■	■	■	■	■	■	■	■	■	■	■	■	■	■	■	■	■	■
<b>External operation panel</b>																				
16.1	External operation panel		■	■	■	■	■	■	■	■	■	■	■	■	■	■	■	■	■	■
<b>Wipe-down system</b>																				
17.1	Wipe-down roller, one-sided		■	■	■	■	■	-	-	-	-	-	-	-	-	-	-	-	-	-
	Wipe-down roller, both-sided		-	-	-	-	-	■	■	■	■	■	■	■	■	■	■	□	□	□
	Wipe-down brush		■	■	■	■	■	■	■	■	■	■	■	■	■	■	■	■	■	■
<b>Assembly aid</b>																				
18.1, 18.2	Fixing bar		■	■	■	■	■	■	■	■	■	■	■	■	■	■	■	■	■	■
<b>Deflection roller</b>																				
19.1-19.3	Deflection roller		■	■	■	■	■	■	■	■	■	■	■	■	■	■	■	■	■	■
<b>Spacer</b>																				
20.1	Spacer for motor-driven winder		■	■	■	■	■	■	■	■	■	■	■	■	■	■	■	■	■	■
<b>Orientation of assembly</b>			<b>vertical</b>		<b>horizontal</b>		<b>vertical</b>		<b>horizontal</b>		<b>vertical</b>		<b>horizontal</b>		<b>vertical</b>		<b>horizontal</b>			
Rewinder diameter	up to mm		210 290	310	210 290	310	210 290	310	210 290	310	210 290	310	210 290	310	310	310				
<b>Counterholder</b>																				
12.1	Counterholder		■	■	-	-	■	■	-	-	■	■	-	-	■	■	-	-	■	-
<b>Cover plate</b>																				
13.1	Cover plate		-	■	-	■	-	■	-	■	-	■	-	■	-	■	■	■		
<b>Device retainer</b>																				
21.1	Device fixed		■	-	■	-	■	-	■	-	■	-	■	-	-	-	-	-	-	
21.2	Device moveable		■	-	-	-	■	-	-	-	■	-	-	-	-	-	-	-	-	
21.3	Device precisely adjustable		■	-	■	-	■	-	■	-	■	-	□	-	-	-	-	-	-	
<b>Device retainer - special equipment</b>																				
21.4-21.6	Pivoted retainer, digital counter, extender		■	-	■	-	■	-	■	-	■	-	■	-	-	-	-	-	-	
<b>Stand</b>																				
22.1-22.4	Column stand, floor stand		■	■	■	■	■	■	■	■	■	■	■	■	■	■	□	□	□	
<b>Stand - special equipment</b>																				
22.5-22.7	Angular gear, digital counter, adjusting disc		■	■	■	■	■	■	■	■	■	■	■	■	■	■	■	■	■	

# Delivery program

## Left-hand construction

Pos.	Part no.	Base units
1.1	<b>6121131</b>	Base unit 124 L
1.2	<b>6121133</b>	Base unit 186 L
1.3	<b>6121135</b>	Base unit 248 L
1.4	<b>6121137</b>	Base unit 310 L
Pos.	Part no.	Unwinders
2.1	<b>5983300</b>	Unwinder D310 H 124 L
	<b>5983302</b>	Unwinder D310 H 186 L
	<b>5983304</b>	Unwinder D310 H 248 L
	<b>6122000</b>	Unwinder D310 VH 62 L
	<b>5983312</b>	Unwinder D310 V 124 L
	<b>5983314</b>	Unwinder D310 V 186 L
2.2	<b>5983316</b>	Unwinder D310 V 248 L
	<b>5983306</b>	Unwinder D410 H 124 L
	<b>5983308</b>	Unwinder D410 H 186 L
	<b>5983310</b>	Unwinder D410 H 248 L
	<b>6122002</b>	Unwinder D410 VH 62 L
	<b>5983318</b>	Unwinder D410 V 124 L
2.3	<b>5983320</b>	Unwinder D410 V 186 L
	<b>5983322</b>	Unwinder D410 V 248 L
	Pos.	Part no.
2.3	<b>5983501</b>	Unwinder D410 H 124 L motor-driven
	<b>5983502</b>	Unwinder D410 H 186 L motor-driven
	<b>5983503</b>	Unwinder D410 H 248 L motor-driven
	<b>5983504</b>	Unwinder D410 H 310 L motor-driven
	<b>5983505</b>	Unwinder D410 V 124 L motor-driven
	<b>5983506</b>	Unwinder D410 V 186 L motor-driven
	<b>5983507</b>	Unwinder D410 V 248 L motor-driven
	<b>5983508</b>	Unwinder D410 V 310 L motor-driven
2.4	<b>5983509</b>	Unwinder D510 H 124 L motor-driven
	<b>5983510</b>	Unwinder D510 H 186 L motor-driven
	<b>5983511</b>	Unwinder D510 H 248 L motor-driven
	<b>5983512</b>	Unwinder D510 V 124 L motor-driven
	<b>5983513</b>	Unwinder D510 V 186 L motor-driven
	<b>5983514</b>	Unwinder D510 V 248 L motor-driven
Pos.	Part no.	Unwinders with a double pendulum
2.5	<b>5983519</b>	Unwinder D410 H 124 L DP motor-driven
	<b>5983520</b>	Unwinder D410 H 186 L DP motor-driven
	<b>5983521</b>	Unwinder D410 H 248 L DP motor-driven
	<b>5983522</b>	Unwinder D410 V 124 L DP motor-driven
	<b>5983523</b>	Unwinder D410 V 186 L DP motor-driven
	<b>5983524</b>	Unwinder D410 V 248 L DP motor-driven
2.6	<b>5983525</b>	Unwinder D510 H 124 L DP motor-driven
	<b>5983526</b>	Unwinder D510 H 186 L DP motor-driven
	<b>5983527</b>	Unwinder D510 V 124 L DP motor-driven
	<b>5983528</b>	Unwinder D510 V 186 L DP motor-driven

Type code: base unit		
Labeling head		<b>186 L</b>
Label web width	62 mm	
	124 mm	
	186 mm	
	248 mm	
	310 mm	
Label application	to the left L	
	to the right R	

## Right-hand construction

Pos.	Part no.	Base units
1.1	<b>6121132</b>	Base unit 124 R
1.2	<b>6121134</b>	Base unit 186 R
1.3	<b>6121136</b>	Base unit 248 R
1.4	<b>6121138</b>	Base unit 310 R
Pos.	Part no.	Unwinders
2.1	<b>5983301</b>	Unwinder D310 H 124 R
	<b>5983303</b>	Unwinder D310 H 186 R
	<b>5983305</b>	Unwinder D310 H 248 R
	<b>6122001</b>	Unwinder D310 VH 62 R
	<b>5983313</b>	Unwinder D310 V 124 R
	<b>5983315</b>	Unwinder D310 V 186 R
2.2	<b>5983317</b>	Unwinder D310 V 248 R
	<b>5983307</b>	Unwinder D410 H 124 R
	<b>5983309</b>	Unwinder D410 H 186 R
	<b>5983311</b>	Unwinder D410 H 248 R
	<b>6122003</b>	Unwinder D410 VH 62 R
	<b>5983319</b>	Unwinder D410 V 124 R
2.3	<b>5983321</b>	Unwinder D410 V 186 R
	<b>5983323</b>	Unwinder D410 V 248 R
	Pos.	Part no.
2.3	<b>5983540</b>	Unwinder D410 H 124 R motor-driven
	<b>5983541</b>	Unwinder D410 H 186 R motor-driven
	<b>5983542</b>	Unwinder D410 H 248 R motor-driven
	<b>5983543</b>	Unwinder D410 H 310 R motor-driven
	<b>5983544</b>	Unwinder D410 V 124 R motor-driven
	<b>5983545</b>	Unwinder D410 V 186 R motor-driven
	<b>5983546</b>	Unwinder D410 V 248 R motor-driven
	<b>5983547</b>	Unwinder D410 V 310 R motor-driven
2.4	<b>5983548</b>	Unwinder D510 H 124 R motor-driven
	<b>5983549</b>	Unwinder D510 H 186 R motor-driven
	<b>5983550</b>	Unwinder D510 H 248 R motor-driven
	<b>5983551</b>	Unwinder D510 V 124 R motor-driven
	<b>5983552</b>	Unwinder D510 V 186 R motor-driven
	<b>5983553</b>	Unwinder D510 V 248 R motor-driven
Pos.	Part no.	Unwinders with a double pendulum
2.5	<b>5983558</b>	Unwinder D410 H 124 R DP motor-driven
	<b>5983559</b>	Unwinder D410 H 186 R DP motor-driven
	<b>5983560</b>	Unwinder D410 H 248 R DP motor-driven
	<b>5983561</b>	Unwinder D410 V 124 R DP motor-driven
	<b>5983562</b>	Unwinder D410 V 186 R DP motor-driven
	<b>5983563</b>	Unwinder D410 V 248 R DP motor-driven
2.6	<b>5983564</b>	Unwinder D510 H 124 R DP motor-driven
	<b>5983565</b>	Unwinder D510 H 186 R DP motor-driven
	<b>5983566</b>	Unwinder D510 V 124 R DP motor-driven
	<b>5983567</b>	Unwinder D510 V 186 R DP motor-driven

Type code: winders						
<b>Unwinder, rewinder</b>		<b>D410</b>	<b>H</b>	<b>124</b>	<b>L</b>	<b>DP</b>
Outside diameter	up to 210 mm					
	290 mm					
	310 mm					
	410 mm					
	510 mm					
	610 mm					
Orientation of assembly	vertical V					
	horizontal H					
Label web width	62 mm					
	124 mm					
	186 mm					
	248 mm					
	310 mm					
Label application	to the left L					
	to the right R					
Pendulum	double					

# Delivery program





















## Left-hand construction















Pos.	Part no.	Rewinders	
3.1	<b>6122030</b>	Rewinder D210 62 L	
	<b>6122034</b>	Rewinder D210 124 L	
	<b>6122038</b>	Rewinder D210 186 L	
	<b>6122042</b>	Rewinder D210 248 L	
3.2	<b>6122032</b>	Rewinder D290 62 L	
	<b>6122036</b>	Rewinder D290 124 L	
	<b>6122040</b>	Rewinder D290 186 L	
	<b>6122044</b>	Rewinder D290 248 L	
Pos.	Part no.	Rewinders motor-driven	
3.3	<b>5983531</b>	Rewinder D310 124 L motor-driven	
	<b>5983532</b>	Rewinder D310 186 L motor-driven	
	<b>5983533</b>	Rewinder D310 248 L motor-driven	
	<b>5983534</b>	Rewinder D310 310 L motor-driven	
	3.4	<b>5983535</b>	Rewinder D410 124 L motor-driven
		<b>5983536</b>	Rewinder D410 186 L motor-driven
<b>5983537</b>		Rewinder D410 248 L motor-driven	
Pos.	Part no.	Peel-off plates standard	
4.1	<b>6126000</b>	Peel-off plate 100 mm 62 L	
	<b>6126001</b>	Peel-off plate 100 mm 124 L	
	<b>6126002</b>	Peel-off plate 100 mm 186 L	
	<b>6126003</b>	Peel-off plate 100 mm 248 L	
4.2	<b>6126004</b>	Peel-off plate 100 mm 310 L	
	<b>6126010</b>	Peel-off plate 160 mm 62 L	
	<b>6126011</b>	Peel-off plate 160 mm 124 L	
	<b>6126012</b>	Peel-off plate 160 mm 186 L	
	<b>6126013</b>	Peel-off plate 160 mm 248 L	
	<b>6126014</b>	Peel-off plate 160 mm 310 L	
4.3	<b>6127475</b>	Roller enabling smoother web run 62 L	
	<b>6127476</b>	Roller enabling smoother web run 124 L	
	<b>6127477</b>	Roller enabling smoother web run 186 L	
	<b>6127478</b>	Roller enabling smoother web run 248 L	
	<b>6127479</b>	Roller enabling smoother web run 310 L	
Pos.	Part no.	Peel-off plates adjustable 0° to +75°	
4.4	<b>6126020</b>	Peel-off plate 100 mm 62 L adjustable	
	<b>6126021</b>	Peel-off plate 100 mm 124 L adjustable	
	<b>6126022</b>	Peel-off plate 100 mm 186 L adjustable	
	<b>6126023</b>	Peel-off plate 100 mm 248 L adjustable	
4.5	<b>6126030</b>	Peel-off plate 160 mm 62 L adjustable	
	<b>6126031</b>	Peel-off plate 160 mm 124 L adjustable	
	<b>6126032</b>	Peel-off plate 160 mm 186 L adjustable	
	<b>6126033</b>	Peel-off plate 160 mm 248 L adjustable	
Pos.	Part no.	Peel-off plates pivoted 0° to -30°	
4.6	<b>6126060</b>	Peel-off plate 100 mm 62 L pivoted	
	<b>6126061</b>	Peel-off plate 100 mm 124 L pivoted	
	<b>6126062</b>	Peel-off plate 100 mm 186 L pivoted	
	<b>6126063</b>	Peel-off plate 100 mm 248 L pivoted	
4.7	<b>6126070</b>	Peel-off plate 160 mm 62 L pivoted	
	<b>6126071</b>	Peel-off plate 160 mm 124 L pivoted	
	<b>6126072</b>	Peel-off plate 160 mm 186 L pivoted	
	<b>6126073</b>	Peel-off plate 160 mm 248 L pivoted	
4.8	<b>5955735</b>	Compressed air regulation unit L	
Pos.	Part no.	Peel-off plates 75° with a wipe-down roller	
4.9	<b>6127800</b>	Peel-off plate 75° L x W: 50 x 42 mm	
	<b>6127801</b>	Peel-off plate 75° L x W: 50 x 62 mm	
	<b>6127802</b>	Peel-off plate 75° L x W: 50 x 82 mm	
	<b>6127803</b>	Peel-off plate 75° L x W: 100 x 82 mm	
4.10	<b>6120052</b>	Installation profile for a plate 75° 124 L	
	<b>6120056</b>	Installation profile for a plate 75° 186 L	
	<b>6120060</b>	Installation profile for a plate 75° 248 L	

## Right-hand construction











Pos.	Part no.	Rewinders	
3.1	<b>6122031</b>	Rewinder D210 62 R	
	<b>6122035</b>	Rewinder D210 124 R	
	<b>6122039</b>	Rewinder D210 186 R	
	<b>6122043</b>	Rewinder D210 248 R	
3.2	<b>6122033</b>	Rewinder D290 62 R	
	<b>6122037</b>	Rewinder D290 124 R	
	<b>6122041</b>	Rewinder D290 186 R	
	<b>6122045</b>	Rewinder D290 248 R	
Pos.	Part no.	Rewinders motor-driven	
3.3	<b>5983570</b>	Rewinder D310 124 R motor-driven	
	<b>5983571</b>	Rewinder D310 186 R motor-driven	
	<b>5983572</b>	Rewinder D310 248 R motor-driven	
	<b>5983573</b>	Rewinder D310 310 R motor-driven	
	3.4	<b>5983574</b>	Rewinder D410 124 R motor-driven
		<b>5983575</b>	Rewinder D410 186 R motor-driven
<b>5983576</b>		Rewinder D410 248 R motor-driven	
Pos.	Part no.	Peel-off plates standard	
4.1	<b>6126005</b>	Peel-off plate 100 mm 62 R	
	<b>6126006</b>	Peel-off plate 100 mm 124 R	
	<b>6126007</b>	Peel-off plate 100 mm 186 R	
	<b>6126008</b>	Peel-off plate 100 mm 248 R	
4.2	<b>6126009</b>	Peel-off plate 100 mm 310 R	
	<b>6126015</b>	Peel-off plate 160 mm 62 R	
	<b>6126016</b>	Peel-off plate 160 mm 124 R	
	<b>6126017</b>	Peel-off plate 160 mm 186 R	
	<b>6126018</b>	Peel-off plate 160 mm 248 R	
	<b>6126019</b>	Peel-off plate 160 mm 310 R	
4.3	<b>6127480</b>	Roller enabling smoother web run 62 R	
	<b>6127481</b>	Roller enabling smoother web run 124 R	
	<b>6127482</b>	Roller enabling smoother web run 186 R	
	<b>6127483</b>	Roller enabling smoother web run 248 R	
	<b>6127484</b>	Roller enabling smoother web run 310 R	
Pos.	Part no.	Peel-off plates adjustable 0° to +75°	
4.4	<b>6126025</b>	Peel-off plate 100 mm 62 R adjustable	
	<b>6126026</b>	Peel-off plate 100 mm 124 R adjustable	
	<b>6126027</b>	Peel-off plate 100 mm 186 R adjustable	
	<b>6126028</b>	Peel-off plate 100 mm 248 R adjustable	
4.5	<b>6126035</b>	Peel-off plate 160 mm 62 R adjustable	
	<b>6126036</b>	Peel-off plate 160 mm 124 R adjustable	
	<b>6126037</b>	Peel-off plate 160 mm 186 R adjustable	
	<b>6126038</b>	Peel-off plate 160 mm 248 R adjustable	
Pos.	Part no.	Peel-off plates pivoted 0° to -30°	
4.6	<b>6126065</b>	Peel-off plate 100 mm 62 R pivoted	
	<b>6126066</b>	Peel-off plate 100 mm 124 R pivoted	
	<b>6126067</b>	Peel-off plate 100 mm 186 R pivoted	
	<b>6126068</b>	Peel-off plate 100 mm 248 R pivoted	
4.7	<b>6126075</b>	Peel-off plate 160 mm 62 R pivoted	
	<b>6126076</b>	Peel-off plate 160 mm 124 R pivoted	
	<b>6126077</b>	Peel-off plate 160 mm 186 R pivoted	
	<b>6126078</b>	Peel-off plate 160 mm 248 R pivoted	
4.8	<b>5955736</b>	Compressed air regulation unit R	
Pos.	Part no.	Peel-off plates 75° with a wipe-down roller	
4.9	<b>6127800</b>	Peel-off plate 75° L x W: 50 x 42 mm	
	<b>6127801</b>	Peel-off plate 75° L x W: 50 x 62 mm	
	<b>6127802</b>	Peel-off plate 75° L x W: 50 x 82 mm	
	<b>6127803</b>	Peel-off plate 75° L x W: 100 x 82 mm	
4.10	<b>6120054</b>	Installation profile for a plate 75° 124 R	
	<b>6120058</b>	Installation profile for a plate 75° 186 R	
	<b>6120062</b>	Installation profile for a plate 75° 248 R	













# Delivery program

Pos.	Part no.	Label margin detection
5.1	 <b>5983588</b>	Label sensor CEON
5.2	 <b>6127425</b>	Retainer bar label sensor CEON on peel-off plate Label web width 62 mm
	 <b>6127426</b>	Retainer bar label sensor CEON on peel-off plate Label web width 124 mm
5.3	 <b>5918670</b>	Forked light barrier
5.4	 <b>5972608</b>	Retainer to assemble forked light barrier
Pos.	Part no.	Software keys
6.1	 <b>5581001</b>	Speed key 12 m/min
	<b>5581002</b>	Speed key 25 m/min
	<b>5581003</b>	Speed key 50 m/min
	<b>5581028</b>	Speed key 75 m/min
	<b>5581004</b>	Speed key 100 m/min
	<b>5581005</b>	Speed key 150 m/min
<b>5581006</b>	Speed key 200 m/min	
Pos.	Part no.	Rods to assemble a peel-off plate
7.1	 <b>5972443</b>	Assembly rod, diameter 16 mm Distance to the device 0 mm
	 <b>5972418</b>	Assembly rod, diameter 16 mm Distance to the device 100 mm
	 <b>5972703</b>	Assembly rod, diameter 16 mm Distance to the device 150 mm
	 <b>5972419</b>	Assembly rod, diameter 16 mm Distance to the device 200 mm
	 <b>5972420</b>	Assembly rod, diameter 16 mm Distance to the device 300 mm
	 <b>6120067</b>	Assembly rod, diameter 16 mm Distance to the device 400 mm
	 <b>5972421</b>	Assembly rod, diameter 16 mm Distance to the device 600 mm
Pos.	Part no.	Product detection
8.1	 <b>5918702</b>	Product sensor, light switch up to 200 mm
	<b>5918703</b>	Product sensor, light switch with transparent products up to 80 mm
8.2	 <b>5918671</b>	Product sensor cable M12-M8, 4 pin, a-coded, length 2.5 m
Pos.	Part no.	Masterencoder
9.1	 <b>5918979</b>	Rotary encoder with cable 2.5 m
9.2	 <b>5918475</b>	Extender cable for rotary encoder M12, 5 pin, a-coded, length 2.5 m
	 <b>5918942</b>	Extender cable for rotary encoder M12, 5 pin, a-coded, length 10 m
	 <b>5918949</b>	Rotary extender cable M12, 5 pin, a-coded, length 5 m
9.3	 <b>5918981</b>	Friction wheel for rotary encoder
9.4	 <b>5918980</b>	Retainer for rotary encoder

Pos.	Part no.	Power supply cables
10.1	 <b>5918758</b>	Power supply cable without Schuko plug Length 2.5 m
	<b>5918947</b>	Power supply cable without Schuko plug Length 5 m
	<b>5918943</b>	Power supply cable without Schuko plug Length 10 m
10.2	 <b>5918531</b>	Power supply cable with Schuko plug Length 2.5 m
Pos.	Part no.	Signal cables
10.3	 <b>5918421</b>	I/O interface extender cable M12, 17 pin, length 2.5 m
	<b>5918941</b>	I/O interface extender cable M12, 17 pin, length 10 m
10.4	 <b>5918948</b>	I/O interface cable M12, 17 pin, length 5 m
	 <b>5918940</b>	Signal cable applicator, I/O box, winder I/O M12, 12 pin, length 1 m
10.5	 <b>5918477</b>	Signal cable applicator, I/O box, winder I/O M12, 12 pin, length 2.5 m
Pos.	Part no.	LAN cables
10.6	 <b>5918665</b>	Ethernet cable M12, 4 pin d-coded to RJ45, length 2.5 m
	<b>5918946</b>	Ethernet cable M12, 4 pin d-coded to RJ45, length 5 m
	<b>5918945</b>	Ethernet cable M12, 4 pin d-coded to RJ45, length 10 m
Pos.	Part no.	USB cables
10.7	 <b>5918955</b>	Cable to connect an external operation panel, M12, 12 pin to USB-B, length 5 m
10.8	 <b>5918936</b>	USB adapter to connect a memory stick, cable M12, 12 pin to USB-A, length 0.2 m
Pos.	Part no.	Power cables to connect winders or winders with the base unit
10.9	 <b>5918944</b>	Power cable, length 0.3 m
	<b>5918879</b>	Power cable, length 0.8 m
	<b>5918426</b>	Power cable, length 2.5 m
Pos.	Part no.	Interfaces
11.1	 <b>6121010</b>	I/O box M12, 12 pin and 12 x M8, 3 pin to connect base unit
	 <b>6121030</b>	Module IXOR-Powerbus to connect motor-driven winders
Pos.	Part no.	Counterholders
12.1	 <b>5983324</b>	Counterholder 310 mm
	<b>5983325</b>	Counterholder 410 mm
	<b>5983586</b>	Counterholder 510 mm
Pos.	Part no.	Cover plate
13.1	 <b>5983429</b>	Cover plate

# Delivery program

Pos.	Part no.	Circular connectors
14.1	 <b>5918479</b>	Cable plug M12, 5 pin, a-coded, male
	<b>5918483</b>	Cable plug M12, 12 pin, male
14.2	 <b>5918480</b>	Cable jack M12, 5 pin, a-coded, female
	<b>5918484</b>	Cable jack M12, 12 pin, female
Pos.	Part no.	Signal
15.1	 <b>5971223</b>	Warning light with cable length 2.5 m M12, 17 pin
Pos.	Part no.	External operation panel
16.1	 <b>6121020</b>	External operation panel 4.3"
Pos.	Part no.	Wipe-down systems
17.1		Wipe-down rollers for peel-off plates standard, adjustable and pivoted
		<b>6126150</b> Wipe-down roller 62
		<b>6126151</b> Wipe-down roller 124
		<b>6126152</b> Wipe-down roller 186
		<b>6126153</b> Wipe-down roller 248
		Wipe-down brushes for peel-off plates standard, adjustable and pivoted
		<b>6126160</b> Wipe-down brush 62
		<b>6126161</b> Wipe-down brush 124
		<b>6126162</b> Wipe-down brush 186
		<b>6126163</b> Wipe-down brush 248
<b>6126164</b> Wipe-down brush 310		
Pos.	Part no.	Assembly aids
18.1	 <b>6120016</b>	Fixing bar compact to pick up motor-driven winders and base unit
18.2	 <b>6120015</b>	Fixing bar universal to pick up motor-driven winders and base unit
Pos.	Part no.	Deflection rollers
19.1		<b>6127290</b> Deflection roller 62 D30 AL
		<b>6127291</b> Deflection roller 124 D30 AL
		<b>6127292</b> Deflection roller 186 D30 AL
		<b>6127293</b> Deflection roller 248 D30 AL
		<b>6127294</b> Deflection roller 310 D30 AL
		<b>6127295</b> Deflection roller 62 D38 AL
		<b>6127296</b> Deflection roller 124 D38 AL
		<b>6127297</b> Deflection roller 186 D38 AL
		<b>6127298</b> Deflection roller 248 D38 AL
		<b>6127299</b> Deflection roller 310 D38 AL
		<b>6127311</b> Deflection roller 62 D60 AL
		<b>6127312</b> Deflection roller 124 D60 AL
		<b>6127313</b> Deflection roller 186 D60 AL
		<b>6127314</b> Deflection roller 248 D60 AL
		<b>6127315</b> Deflection roller 310 D60 AL
Pos.	Part no.	Spacer
20.1	 <b>6120018</b>	Spacer for motor-driven winder

Pos.	Part no.	Device retainers
21.1		<b>5983401</b> Device 124 fixed
		<b>5983402</b> Device 186 fixed
		<b>5983403</b> Device 248 fixed
		<b>5983404</b> Device 310 fixed
		<b>5983405</b> Device 124 fixed, pivoted
		<b>5983406</b> Device 186 fixed, pivoted
		<b>5983407</b> Device 248 fixed, pivoted
		<b>5983408</b> Device 310 fixed, pivoted
		<b>5983409</b> Device 124 moveable
		<b>5983410</b> Device 186 moveable
21.2		<b>5983411</b> Device 248 moveable
		<b>5983412</b> Device 310 moveable
		<b>5983413</b> Device 124 precisely adjustable
21.3		<b>5983414</b> Device 186 precisely adjustable
		<b>5983415</b> Device 248 precisely adjustable
		<b>5983416</b> Device 310 precisely adjustable
Pos.	Part no.	Device retainers - special equipment
21.4	 <b>5971614</b>	Pivoted retainer
21.5		<b>5983431</b> Digital counter, vertical axis
		<b>5983432</b> Digital counter, horizontal axis
21.6	 <b>5983428</b>	Digital counter extender (for device retainers and stands)
Pos.	Part no.	Stands
22.1		<b>5983420</b> Column stand diameter 30 mm, one axis, height 400 mm
		<b>5983421</b> Column stand diameter 30 mm, one axis, height 600 mm
		<b>5983422</b> Column stand diameter 30 mm, one axis, height 800 mm
22.2		<b>5983423</b> Column stand diameter 30 mm, two axes, height 600 mm, width 400 mm
		<b>5983424</b> Column stand diameter 30 mm, two axes, height 600 mm, width 600 mm
22.3	 <b>5983425</b>	Floor stand 1632 vertical column stand included diameter 30 mm, height 800 mm
22.4	 <b>5983426</b>	Floor stand 1231 horizontal column stand included diameter 30 mm, height 600 mm
Pos.	Part no.	Stands - special equipment
22.5	 <b>5983427</b>	Angular gear
22.6		<b>5983417</b> Digital counter, vertical axis
		<b>5983418</b> Digital counter, horizontal axis
22.7	 <b>5972532</b>	Adjusting disc

# Overview of cab products

Label printers  
**MACH1, MACH2**



Label printers  
**EOS 2**



Label printers  
**EOS 5**



Label printers  
**MACH 4S**



Label printers  
**SQUIX 2**



Label printers  
**SQUIX 4**



Label printers  
**SQUIX 6.3**



Label printers  
**SQUIX 8.3**



Label printers  
**XD Q double-sided**



Label printers  
**XC Q two-colored**



Print and apply systems  
**HERMES Q**



Print and apply systems  
**Hermes C two-colored**

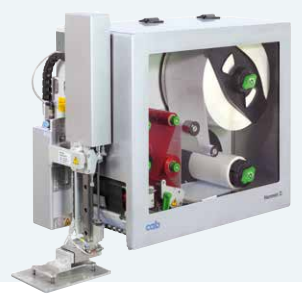

Tube labeling systems  
**AXON 1**



Print modules  
**PX Q**



Labels and ribbons



Label software  
**cablabel S3**



Label dispensers  
**HS, VS**



Labeling heads  
**IXOR**



Marking lasers  
**XENO 4**



Laser marking systems



Germany  
**cab Produkttechnik GmbH & Co KG**  
Karlsruhe  
Phone +49 721 6626 0  
[www.cab.de](http://www.cab.de)

France  
**cab Technologies S.à.r.l.**  
Niedermodern  
Phone +33 388 722501  
[www.cab.de/fr](http://www.cab.de/fr)

USA  
**cab Technology, Inc.**  
Chelmsford, MA  
Phone +1 978 250 8321  
[www.cab.de/us](http://www.cab.de/us)

Mexico  
**cab Technology, Inc.**  
Juárez  
Phone +52 656 682 4301  
[www.cab.de/es](http://www.cab.de/es)

Taiwan  
**cab Technology Co., Ltd.**  
Taipei  
Phone +886 (02) 8227 3966  
[www.cab.de/tw](http://www.cab.de/tw)

China  
**cab (Shanghai) Trading Co., Ltd.**  
Shanghai  
Phone +86 (021) 6236 3161  
[www.cab.de/cn](http://www.cab.de/cn)

Singapore  
**cab Singapore Pte. Ltd.**  
Singapore  
Phone +65 6931 9099  
[www.cab.de/en](http://www.cab.de/en)

South Africa  
**cab Technology (Pty) Ltd.**  
Randburg  
Phone +27 11 886 3580  
[www.cab.de/za](http://www.cab.de/za)

**cab // 820** distribution and service partners in more than **80** countries

**cab**  
*we identify more*